

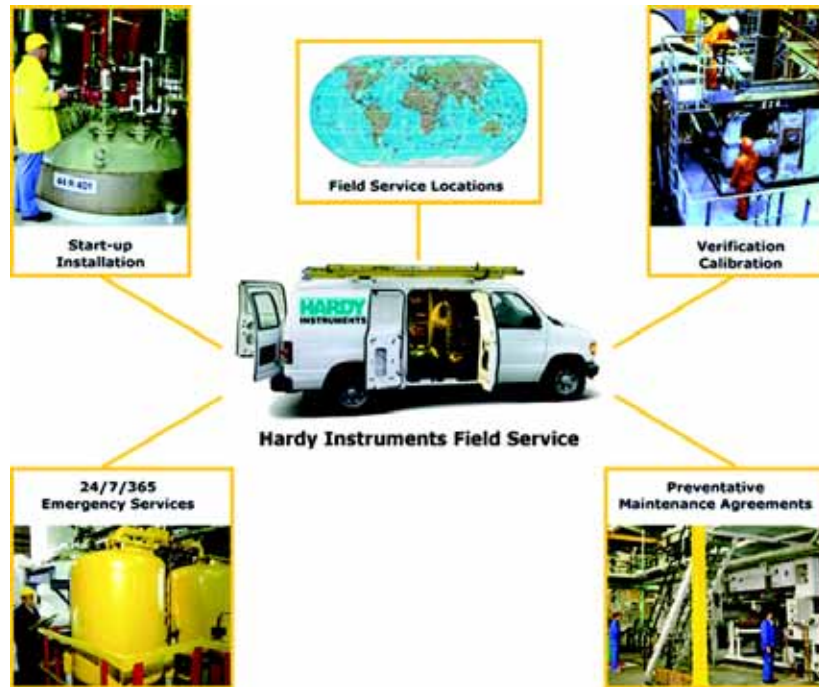


**Remote I/O**

**HI 4000 Series**

**User's Guide**





## Local Field Service

Hardy has over 200 field technicians in the U.S., and more positioned throughout the world to assist you in your support needs. We also have factory engineers who will travel to your facility anywhere in the world to help you solve challenging applications. We're ready to support you with:

- **Installation and start-up**
- **Routine maintenance and certification**
- **Plant audits and performance measurement**
- **Emergency troubleshooting and repair**

To request Emergency Service and Troubleshooting, Start-up, Installation, Calibration, Verification or to discuss a Maintenance Agreement please call **800-821-5831 Ext. 1757** or Emergency Service after hours (Standard Hours 6:00 AM to 6:00 PM Pacific Standard Time) and weekends Ext. 1111.

## Outside the U.S

Hardy Instruments has built a network of support throughout the globe. For specific field service options available in your area please contact your local sales agent or our U.S. factory at **+1 858-292-2710, Ext. 1757**.

# Contents

•••••

<b>Chapter 1</b>	<b>Overview</b>	<b>1</b>
	Allen-Bradley License	1
	Configuration Modes	2
	/30 Compatibility (Default 4050 Only)	2
	Mapping	2
<b>Chapter 2</b>	<b>Specification and Installation</b>	<b>5</b>
	Remote I/O Board Cable Termination Dip Switch Configuration	5
	About Cable Termination	5
	Setting the Cable Termination Dip Switches	6
	Installing the RIO Option Board	6
	Status LED	10
<b>Chapter 3</b>	<b>Configuration</b>	<b>13</b>
	Configuration from the Front Panel	13
	Configuring the RIO Baud Rate	15
	Configuring the RIO Address	15
	Configuring RIO Rack Size	17
	Selecting the RIO Starting Quarter	16
	Confirming RIO Last Quarter	18
	Selecting the Compatibility Mode (4050 Only)	19
	Configuration from the Web Browser	20
	Blind Unit Operation Setup	26
	About Blind Units	26
<b>Chapter 4</b>	<b>Discrete Transfers</b>	<b>27</b>
	Discrete Writes for HI 2151/30 Compatibility	27
	Structure of the Two Words in the PLC Output Image Table	27
	Bit Shift	27

Weight Parameter	- - - - -	28
Status Byte	- - - - -	28
Example	- - - - -	29
Discrete Writes in Mapping (HI 4000 Series) Compatibility	- - - - -	29
Discrete Reads for HI 2151/30 Compatibility	- - - - -	29
0 = Setpoint Status Byte	- - - - -	29
2 = Indicator Group 2 Status Byte	- - - - -	30
3 = Indicator Group 1 Status Byte	- - - - -	30
8 = MSB of 24 Bit Weight Value	- - - - -	30
Example of Screen Printout	- - - - -	31
Discrete Reads in Mapping (HI 4000 Series) Compatibility	- - - - -	31

## **Chapter 5 Block Transfers - - - - - 33**

About Block Transfers	- - - - -	33
/30 Mode	- - - - -	34
Mapping Mode	- - - - -	34
Block Read Commands	- - - - -	34
Block Read Command Number 1: Full Status and Weight Data	- - - - -	34
Block Read Command Number 2: Setpoint Relay Parameter	- - - - -	37
About Set Points	- - - - -	38
Set Point Limits	- - - - -	38
Dead Band Limits	- - - - -	38
Three General Rules for Set Points	- - - - -	38
Preact Limits	- - - - -	39
Mode	- - - - -	39
Type	- - - - -	39
Example of Proper Setpoint Description Bytes	- - - - -	40
Block Read Command Number 3: Instrument Identification and Diagnostics	- - - - -	41
Block Read Command Number 4: Read Tare Value	- - - - -	42
Block Read Command Number 5: Calibration Parameters	- - - - -	42
Block Read Command Number 6: Configuration of Rate-of-Change	- - - - -	43
Block Read Command Number 7: BCD Output Configuration	- - - - -	44
Block Read Command Number 8: Configuration of Analog Output	- - - - -	45
Block Read Command Number 11: Auto Zero Tolerance	- - - - -	46
Block Read Command Number 12: Integrated Technician	- - - - -	46
Block Transfer Read Example	- - - - -	47
Block Write Commands	- - - - -	49
About Block Write Commands	- - - - -	49
Block Write Command Number 51: Activate Scale Functions	- - - - -	49
Block Write Command Number 52: Downloading Setpoint	- - - - -	

Relay Parameters	- - - - -	50
Example of Proper Setpoint Description Bytes	- - - - -	52
Block Write Command Number 53: Send Tare Value	- - - - -	53
Block Write Command Number 54: Scale Calibration Action	- - - - -	54
Block Write Command Number 55: Calibration Parameters	- - - - -	55
Block Write Command Number 56: Configuration of		
Rate-of-Change	- - - - -	56
Block Write Command Number 61: Auto Zero Tolerance	- - - - -	57
Block Write Command Number 62: Waversaver/Excitation		
Monitor	- - - - -	57
Block Transfer Write Example	- - - - -	58
Integer to Floating Point Routine	- - - - -	60
Response and Error Codes	- - - - -	61
Block Read or Block Write Error Codes	- - - - -	62
Block Write Error Codes	- - - - -	62
Error Code for Block Write Command #54	- - - - -	62
Block Write in Mapping Compatibility Mode	- - - - -	63
<b>Chapter 6</b>	<b>Mapping</b>	<b>- - - - - 65</b>
Mapping an Output	- - - - -	65
Mapping an Input	- - - - -	69
<b>Chapter 7</b>	<b>Conversion Charts &amp; Formulas</b>	<b>- - - - - 75</b>
Hex Chart	- - - - -	75
Relay Status Example	- - - - -	75
Block Write Example /30 Mode	- - - - -	77
Math Conversion Programs	- - - - -	77

**Index**



# Illustrations

● ● ● ● ●

**Specifications and Installation - - - - - 5**

FIG. 1 TERMINATION DIP SWITCH - - - - - 6  
 FIG. 2 BOARD STACKER FOR ROI CARD - - - - - 7  
 FIG. 3 ALIGN THE BOARD STACKER PINS WITH THE THROUGH HOLES  
 ON THE MAIN CONTROLLER BOARD - - - - - 8  
 FIG. 4 APPLYING THE RIO LABEL TO THE REAR PANEL - - - - - 9  
 FIG. 5 RIO CARD FASTENED TO REAR PANEL - - - - - 10  
 FIG. 6 STATUS INDICATOR LED - - - - - 11

**Configuration - - - - - 13**

FIG. 7 CONFIGURATION MENU/SELECTION OPTIONS - - - - - 13  
 FIG. 8 OPTIONS MENU/SELECTING RIO - - - - - 14  
 FIG. 9 RIO MENU/SELECTING RIO BAUD RATE - - - - - 14  
 FIG. 10 RIO MENU/SELECTING RIO ADDRESS - - - - - 15  
 FIG. 11 RIO ADDRESS MENU/ENTERING ADDRESS 2 - - - - - 16  
 FIG. 12 RIO MENU/RIO ADDRESS 2 - - - - - 17  
 FIG. 13 RIO MENU/SELECTING RIO RACK SIZE - - - - - 17  
 FIG. 14 RIO MENU/SELECTING RIO QUARTER - - - - - 18  
 FIG. 15 RIO MENU/SELECTING COMPATIBILITY - - - - - 19  
 FIG. 16 HI 4050 HOME PAGE/SELECTING CONFIGURATION - - - - - 20  
 FIG. 17 CONFIGURATION MENU/SELECTING OPTIONS - - - - - 21  
 FIG. 18 OPTIONS MENU/SELECTING RIO CARD - - - - - 21  
 FIG. 19 RIOT OPTION CARD PAGE/SELECTING BAUD RATE - - - - - 22  
 FIG. 20 ENTERING RIO CARD ADDRESS - - - - - 23  
 FIG. 21 SELECTING RACK SIZE - - - - - 24  
 FIG. 22 SELECTING STARTING QUARTER - - - - - 24  
 FIG. 23 SELECTING CONFIRMATION OF LAST QUARTER - - - - - 25  
 FIG. 24 SELECTING COMPATIBILITY MODE - - - - - 25

FIG. 25 CLICKING ON SAVE PARAMETERS BUTTON - - - - - 26

**Discrete Transfers - - - - - 27**

FIG. 26 EXAMPLE OF SCREEN PRINTOUT - - - - - 31

**Block Transfers - - - - - 33**

FIG. 27 GAIN IN WEIGHT/HIGH TRIP LIMIT - - - - - 39

FIG. 28 LOSS IN WEIGHT/LOW TRIP LIMIT - - - - - 39

FIG. 29 BLOCK TRANSFER READ EXAMPLE - - - - - 48

FIG. 30 INTEGER TO FLOATING POINT ROUTINE - - - - - 61

**Mapping - - - - - 65**

FIG. 31 CONFIGURATION MENU/SELECTING MAPPING - - - - - 66

FIG. 32 MAPPING PAGE/SELECTING DESTINATION - - - - - 66

FIG. 33 MAPPING PAGE/SELECTING DESTINATION - - - - - 67

FIG. 34 RI02 APPEARS IN THE ASSIGNMENT STATEMENT - - - - - 67

FIG. 35 SELECTING SOURCE/NET WEIGHT - - - - - 68

FIG. 36 SELECTING A SOURCE/NET WEIGHT HF11 - - - - - 68

FIG. 37 MAPPING NET WEIGHT TO RIO INT OUTPUT WORD 2 - - - - - 69

FIG. 38 NET WEIGHT MAPPED TO THE RIO OUTPUT TABLE - - - - - 69

FIG. 39 DESTINATION/SELECTING TARE COMMAND - - - - - 70

FIG. 40 SELECTING TARE - - - - - 70

FIG. 41 TARE (HO2.0) SELECTED AS A DESTINATION - - - - - 71

FIG. 42 SELECTING A SOURCE/RIO INT IN - - - - - 71

FIG. 43 SELECTING WORD - - - - - 72

FIG. 44 MAPPING RIO INT IN TO TARE - - - - - 72

FIG. 45 RIO INT IN MAPPED TO TARE - - - - - 72



# Chapter 1 Overview



## Allen-Bradley License

Under license from The Allen-Bradley Corporation, Hardy Instruments Inc. has developed a Remote I/O Interface for the HI 4000 Series.

Hardy Instruments worked with substantial customer input from Allen-Bradley to identify that the remote I/O communications network best matched the needs of system integrators and end users for industrial and process applications. The interface is fast, field proven, requires minimal wiring, requires no special software drivers, and is standard on many Allen-Bradley programmable controllers. Setting each address and baud rate in the instrument, connecting three wires, and writing some ladder logic is all that is needed to begin communicating parameters to and from the controller.

Information contained in this manual is subject to change. Always check the latest version of this manual at our web site (<http://www.hardyinst.com>) before beginning system design. This product incorporates technology which is licensed by Allen-Bradley Company Inc. Allen-Bradley does not technically approve, warrant or support this product. All warranty and support for this product is provided by Hardy Instruments Inc.

The HI 4050WC comes with two user selectable compatibilities:

- HI 2151/30
- Mapped HI 4050

### NOTE

*The 4060 does not have HI 2151/30 compatibility, but it uses a non-configurable version of mapping by default. The following paragraphs pertain to the HI 4050WC only.*

Each Hardy Instruments' HI 4050WC in 2151/30 mode represents a quarter (1/4) rack of discrete I/O (32 bits in the PLC Output and Input image files) to the scanning PLC and supports both discrete and block transfers. The PLC continually exchanges 32 bits of its PLC Input Image Table and 32 bits of its Output Image Table with each 1/4 rack device. The Output Image bits are used to send commands to the weight controller and the Input Image bits return weight data and scale status bits. These actions are referred to as "discrete

writes and “discrete reads”. The user is also able to exchange blocks of data with a 1/4 rack device via Block Transfer instructions in the PLC ladder logic program. These commands are referred to as “block writes” and “block reads”.

The host programmable controller can access all configuration and weighing parameters in the HI 4050WC, including performing scale calibration. The HI 4050WC can be used as a local display and keyboard for weighing parameters, or function as a blind controller properly digitizing the load cell signal and providing responsive setpoint control.

Using the Remote I/O interface shortens development time and provides the most functional weighing interface available for your Allen-Bradley programmable controller. Before starting system design, you should also read the Installation and Operation manual of the HI 4050WC.

**NOTE**

*PLC<sup>®</sup>, PLC-2<sup>®</sup>, PLC-3<sup>®</sup>, PLC-5<sup>®</sup>, SLC500<sup>®</sup> Series are registered trademarks of Rockwell Automation.*

## Configuration Modes

**NOTE**

*The 4060 uses a non-configurable version of mapping by default. The following paragraphs pertain to the HI 4050WC only.*

The HI 4050WC enables the user to select between two compatibility modes of operation:

### **/30 Compatibility (Default - 4050 only)**

As the name implies the HI 2151/30 is compatible with the HI2151/30 RIO Block Transfers and discrete Reads and Writes to the instrument. For those who have or had a Hardy HI 2151/30, HI 4000 RIO operation is very similar. However there are some differences, so be aware that not all commands are the same. This eliminates you having to completely rewrite your ladder logic when replacing the HI 2151/30 WC with an HI 4050 WC. In many instances no changes or some minimal changes might be necessary. Unlike the HI 4050, you are limited to a 1/4 rack configuration.

### **Mapping Configuration**

Mapping is used exclusively on the HI 4050WC. You can configure 1/4, 1/2, 3/4 or FULL rack to the instrument. Simply map various sources to the RIO Input table or Output table to connect to the PLC or DCS. The Block and Discrete Reads and Writes are very similar to the HI 2151/30.

# Chapter 2

## Specifications and Installation



### Specifications

#### Approvals

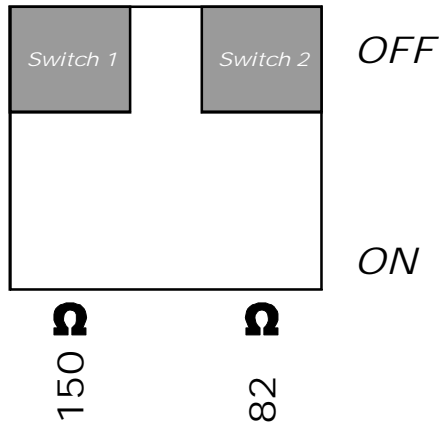
- UL (Pending)
- CUL (Pending)
- Hazardous Class I, Division 2, Groups A,B,C,D, T4A and Class II, Division 2, Groups E,F,G, T4A (Pending)
- NTEP
- CE (Pending)
- CB (Pending)

### Installation

#### Remote I/O Board Cable Termination Dip Switch Configuration

##### About Cable Termination

Weight controllers are connected to a cable in daisy-chain fashion and are referred to as “nodes”. A Daisy Chain is a hardware configuration in which devices are connected one to another in a series. The end nodes on the daisy chain require termination resistors. The Remote I/O board provides the S1 Dip Switches which are used for cable termination based on the baud rate. The S1 Dip Switches are only used on the last device in the daisy chain. For all other devices on the daisy chain both dip switches should be set to OFF. (See Fig. 1)



**FIG. 1 TERMINATION DIP SWITCH**

**NOTE** Refer to your Allen-Bradley PLC-2, PLC-3, PLC-5 and SLC 500 manuals for the maximum number of nodes available.

### Setting the Cable Termination Dip Switches

Step 1. For all RIO board options (except for the last device) make sure the dip switches are set to the OFF position. (See Fig. 1)

**NOTE** The factory default setting is for both switches to be turned OFF.

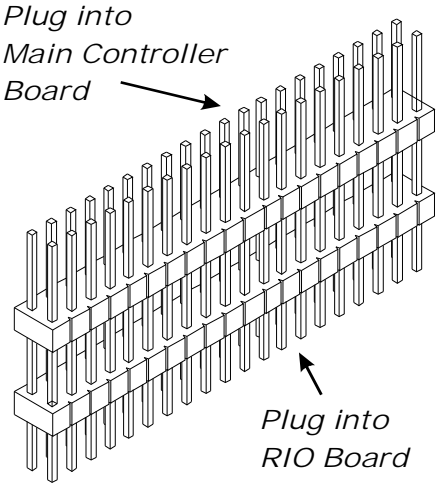
Step 2. On the last RIO board in the daisy chain, select the desired dip switch settings listed in the Table below for Baud Rate.

BAUD	TERMINATION	MAX NODES	MAX LENGTH	SWITCH 1	SWITCH 2
57.6 K	150 Ohms	16	10,000 Feet	ON	OFF
115.2 K	150 Ohms	16	5,000 Feet	ON	OFF
230.4 K	82 Ohms	32	2,500 Feet	OFF	ON

**NOTE** The cable lengths used in above Table are maximum lengths that can be used in the daisy chain.

# Installing the RIO Option Board

Step 1. Plug the Board Stacker into the Network Header (J11) on the RIO board.



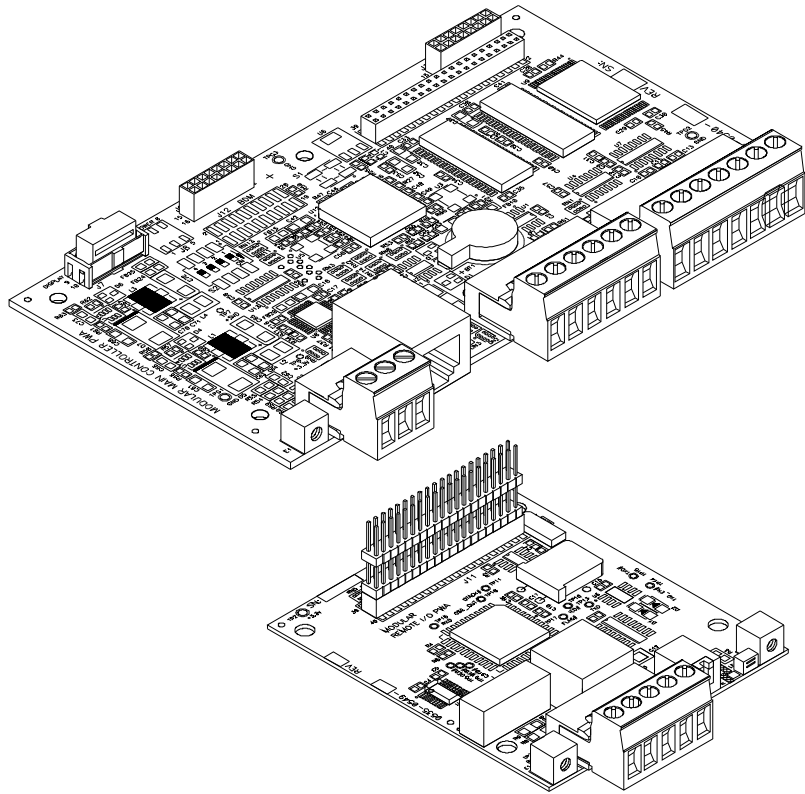
**FIG. 2 BOARD STACKER FOR ROI CARD**

Step 2. There are through holes in the Main Controller board that allow you to plug the Board Stacker into the Network Header. Align the Main Controller Card through holes with the pins of the Board Stacker.

**NOTE**

*Be careful when plugging the RIO Board into the Main Controller board. The pins can be easily bent. Make sure that the long pin section of the Board Stacker are plugged into the Main Controller board.*

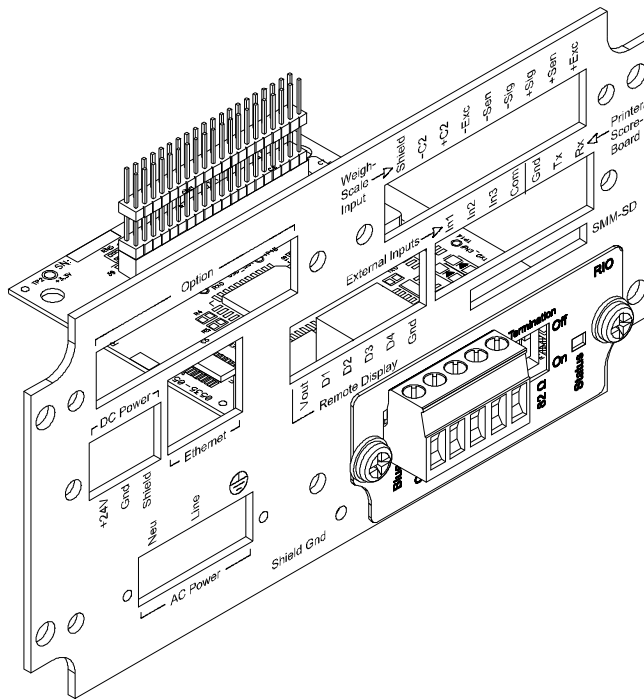
Step 3. Gently push the RIO board stacker pins into the Network header (making sure you align the through holes on the Main Controller board with the 2 standoffs on the RIO board) until the pins are seated. (See Fig. 3)



**FIG. 3 ALIGN THE BOARD STACKER PINS WITH THE THROUGH HOLES ON THE MAIN CONTROLLER BOARD**

- Step 4. Peel the protective cover off the RIO label.
- Step 5. Align the label with the through holes on each side of the Network port. (See Fig. 4)





**FIG. 5 RIO CARD FASTENED TO REAR PANEL (4050 SHOWN)**

Step 8. Connect the cable to the 5 pin connector on the RIO board. The 5 pin connector on the RIO option board is used for all Remote I/O connections. Pin definitions:

Pin 1	BLUE (1/2 of twisted pair)
Pin 2	Clear (1/2 of twisted pair)
Pin 3	SHIELD (outer braided shield)
Pin 4	Clear (1/2 of twisted pair)
Pin 5	BLUE (1/2 of twisted pair)

**NOTE**

*The wiring configuration enables the user to easily daisy chain instruments.*

**Status LED**

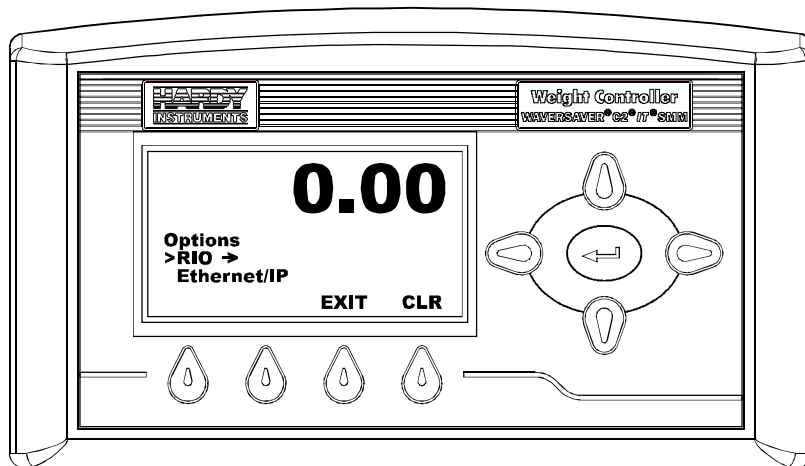
The Status LED is located on the rear panel of the instrument. (See Fig. 6) The status LED indicates the current mode status of the HI 4000 Series RIO. See the table below for the status indicators.







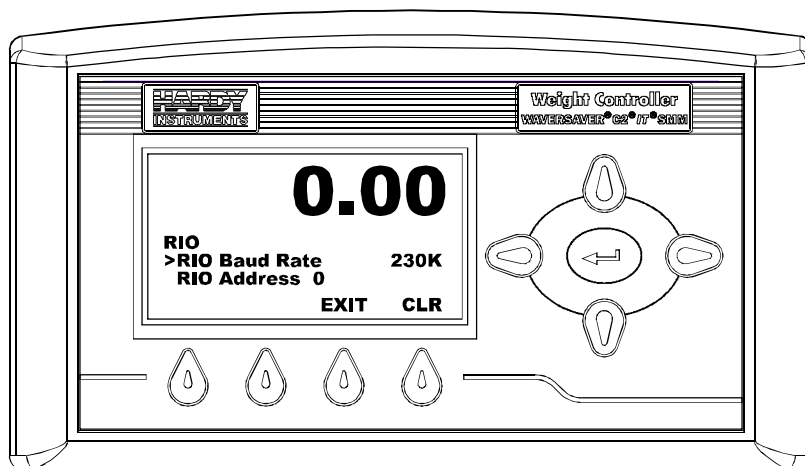




**FIG. 8 OPTIONS MENU/SELECTING RIO**

Step 4. Press the down arrow until the cursor is in front of RIO.

Step 5. Press the Enter button. the RIO Menu appears with cursor in front of RIO Baud Rate. (See Fig. 9)



**FIG. 9 RIO MENU/SELECTING RIO BAUD RATE**

## Configuring the RIO Baud Rate

**PARAMETER: RIO BAUD RATE**

**RANGE: 57.6K, 115K, 230K**

**DEFAULT: 230K**

- Step 1. Use the left or right arrow buttons to select the baud rate (57.6K, 115K or 230K).
- Step 2. Press the Enter button to save the configuration.

### NOTE

*The rack address is decimal and the PLC address is octal.*

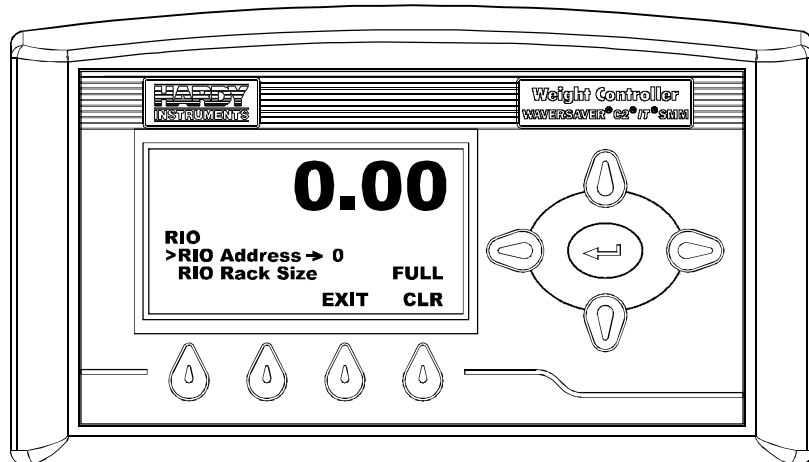
## Configuring the RIO Address

**PARAMETER: RIO ADDRESS**

**RANGE: 0-59**

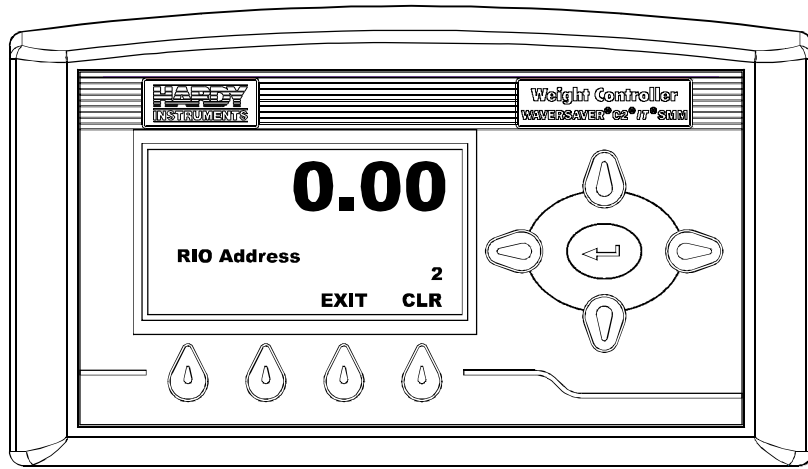
**DEFAULT: 0**

- Step 1. Press the down arrow until the cursor is in front of RIO Address. (See Fig. 10)



**FIG. 10 RIO MENU/SELECTING RIO ADDRESS**

- Step 2. Press the Enter button. The RIO Address Menu appears. (See Fig. 11)



**FIG. 11 RIO ADDRESS MENU/ENTERING ADDRESS 2**

- Step 3. Press the CLR button to clear the current entry.
- Step 4. Use the left arrow button to move the cursor to the left and to delete entered values.
- Step 5. Use the right arrow button to move the cursor to the right.
- Step 6. Use the up arrow button to enter address values. In our example we entered Address 2.
- Step 7. Press the Enter button to save the address. The RIO Menu reappears with the new address. (See Fig. 12)

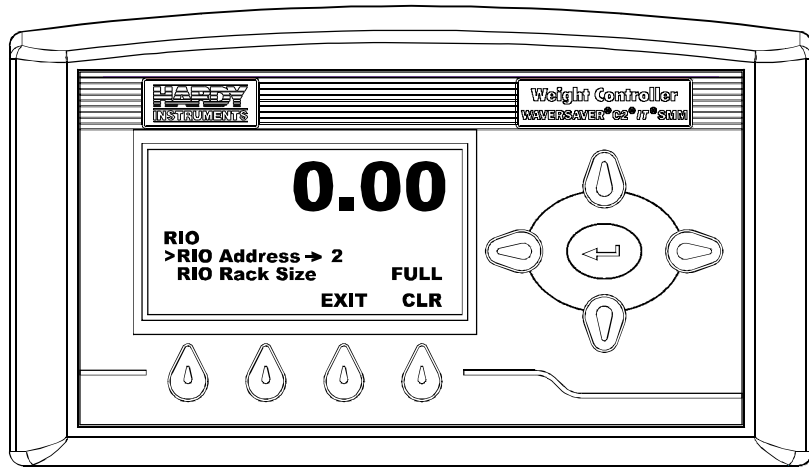


FIG. 12 RIO MENU/RIO ADDRESS 2

### Configuring RIO Rack Size

PARAMETER: RIO RACK SIZE

RANGE: 1/4, 1/2, 3/4, FULL

DEFAULT: 1/4

Step 1. Press the down arrow button until the cursor is in front of RIO Rack Size.

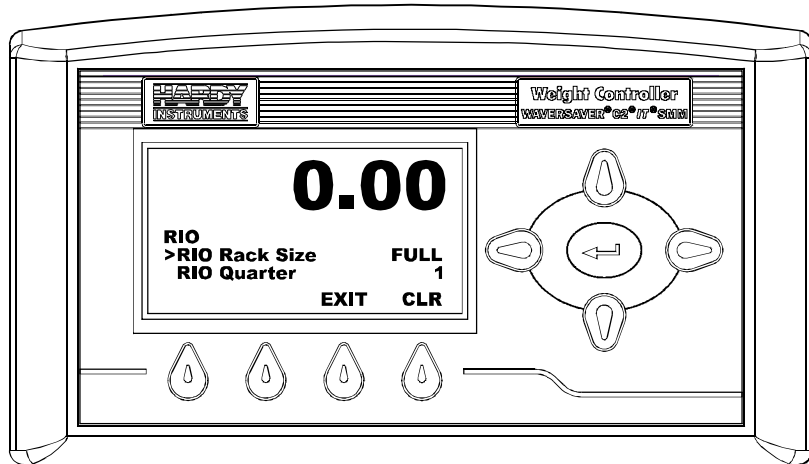


FIG. 13 RIO MENU/SELECTING RIO RACK SIZE

Step 2. Use the left or right arrow buttons to select the Rack size you want for this application.

**NOTE**

*HI 2151/30 compatibility supports the 1/4 rack size only. Mapped supports 1/4, 1/2, 3/4, FULL rack sizes.*

Step 3. Press the Enter button to save the setting.

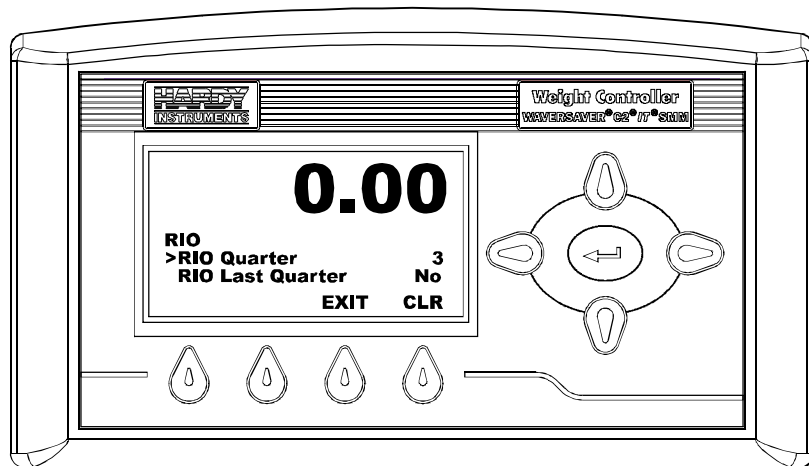
**Selecting the RIO Starting Quarter**

**PARAMETER: RIO QUARTER**

**RANGE: 1-4**

**DEFAULT: 1**

Step 1. Press the down arrow button until the cursor is in front of RIO Quarter. (See Fig. 14)



**FIG. 14 RIO MENU/SELECTING RIO QUARTER**

Step 2. Use the left or right arrow buttons to select the quarter you want for this applications.

Step 3. Press the Enter button to save the setting.

**NOTE**

*The quarter rack number in the PLC is displayed in decimal. Qtr 0 = PLC Group 0, Qtr 1 = PLC Group 2, Qtr 2 = PLC Group 4, Qtr 3 = PLC Group 6.*

**Confirming RIO Last Quarter**

**PARAMETER: RIO LAST QUARTER**

**RANGE: YES/NO**



**DEFAULT: NO**

- Step 1. Press the down arrow button until the cursor is in front of the RIO Last Quarter.
- Step 2. Use the left or right arrow buttons to select Yes or No to indicate whether or not this is the last quarter of the rack currently in use.
- Step 3. Press the Enter button to save the selection.

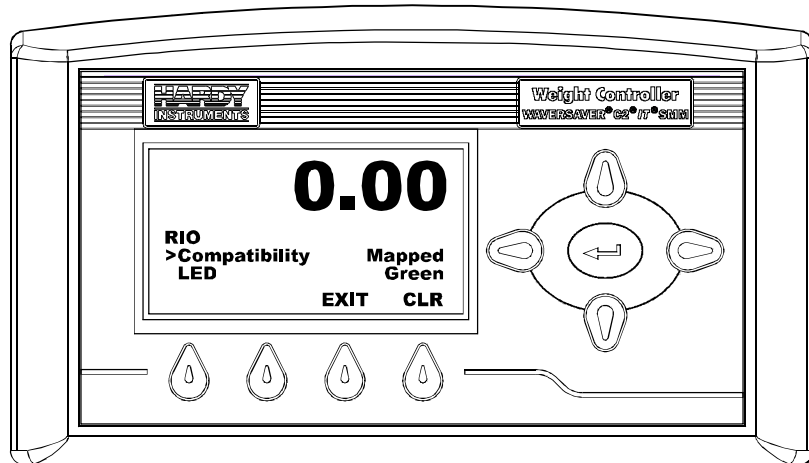
### Selecting the Compatibility Mode (HI 4050 Only)

**PARAMETER: COMPATIBILITY**

**RANGE: MAPPED, HI 2151/30**

**DEFAULT: MAPPED**

- Step 1. Press the down arrow until the cursor is in front Compatibility. (See Fig. 15)



**FIG. 15 RIO MENU/SELECTING COMPATIBILITY**

- Step 2. Use the left or right arrow to select the compatibility you want to use for this application.

**NOTE**

*HI 2151/30 compatibility supports the 1/4 rack size only. Mapped supports 1/4, 1/2, 3/4, FULL rack sizes.*

- Step 3. Press the Enter button to save the selection.

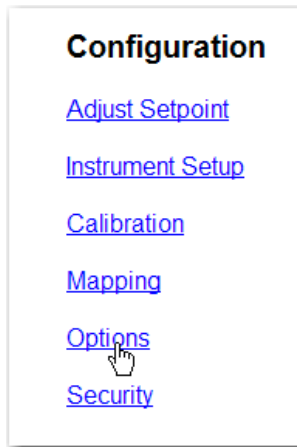
**This completes the front panel RIO Configuration for the instrument.**

## Configuration from the Web Browser

Step 1. From the HI 4050 or HI 4060 Home page, click Configuration. (See Fig. 16) The Configuration Menu appears. (See Fig. 17)

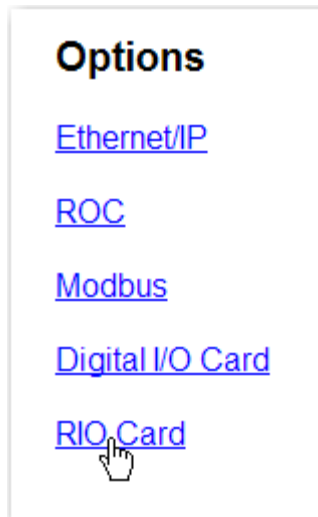


FIG. 16 HI 4050 HOME PAGE/SELECTING CONFIGURATION



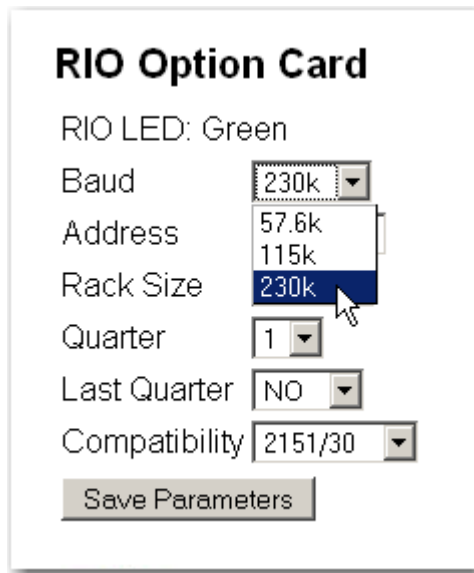
**FIG. 17 CONFIGURATION MENU/SELECTING OPTIONS**

Step 2. Click on Options. The Options Menu appears. (See Fig. 18)



**FIG. 18 OPTIONS MENU/SELECTING RIO CARD**

Step 3. Click on RIO Card. the RIO Option Card page appears. (See Fig. 19)



**FIG. 19 RIOT OPTION CARD PAGE/SELECTING BAUD RATE**

- Step 4. Click on the Baud pull down list.
- Step 5. Click on the Baud rate you need for this application.
- Step 6. Click in the Address text field. (See Fig. 20)

### RIO Option Card

RIO LED: Green

Baud

Address

Rack Size

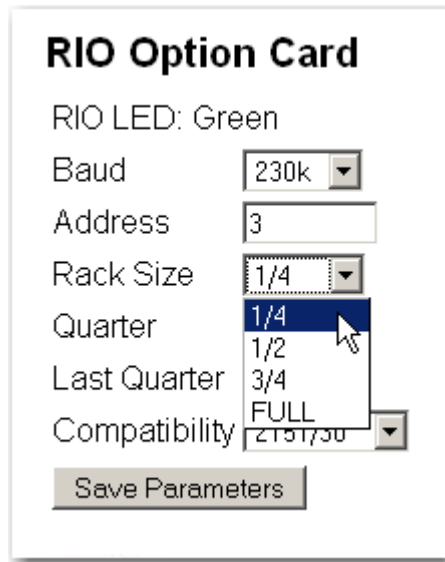
Quarter

Last Quarter

Compatibility

**FIG. 20 ENTERING RIO CARD ADDRESS**

- Step 7. Type in the address for the HI 4050 or HI 4060.
- Step 8. Click on the Rack Size pull down list. (See Fig. 21)



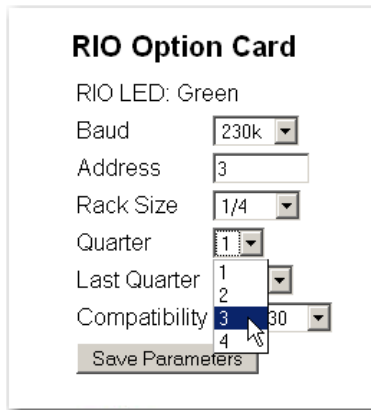
**FIG. 21 SELECTING RACK SIZE**

Step 9. Click on the Rack size you want for this application.

**NOTE**

*HI 2151/30 uses 1/4 rack size only.*

Step 10. Click on the Quarter (Starting Quarter) pull down list. (See Fig. 22)



**FIG. 22 SELECTING STARTING QUARTER**

Step 11. Click on the Starting Quarter you want to use for this application.

Step 12. Click on the Last Quarter Confirmation pull down list. (See Fig. 23)

**RIO Option Card**

RIO LED: Green

Baud 230k

Address 3

Rack Size 1/4

Quarter 3

Last Quarter NO

Compatibility NO

Save Parameters

**FIG. 23 SELECTING CONFIRMATION OF LAST QUARTER**

Step 13. Click on YES if this is the last quarter or NO if it is not. In our example we selected YES.

Step 14. Click on the Compatibility pull down list. (See Fig. 24)

**RIO Option Card**

RIO LED: Green

Baud 230k

Address 3

Rack Size 1/4

Quarter 3

Last Quarter NO

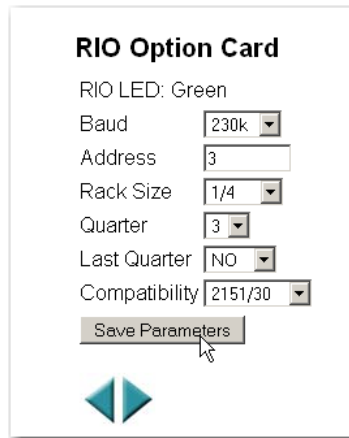
Compatibility 2151/30

Save Parameters

**FIG. 24 SELECTING COMPATIBILITY MODE**

Step 15. Click on the Compatibility mode you want for this applications. Keep in mind the rack size you selected previously. In our example we selected the Mapped compatibility (HI 4050). **Note:** This field does not exist in the HI 4060.

Step 16. Once you have configured the instrument for RIO communication click on the Save Parameters button. (See Fig. 25)



**FIG. 25 CLICKING ON SAVE PARAMETERS BUTTON**

**NOTE**

*You do not have to wait until you have configured the all the parameters to save them. You can Save parameters at any time.*

**This completes the RIO Configuration from the Web Browser**

## Blind Unit Operation Setup

### About Blind Units

An HI 4000 Series DR Controller that cannot be programmed or configured from the front panel is a blind unit. In a blind unit, the Remote I/O parameters are configured from the Web browser.



## Chapter 4 Discrete Transfers



### Discrete Writes for HI 2151/30 Compatibility (HI 450 Only)

The PLC places two sixteen bit words in the Output Image Table which are read by the HI 4050WC weight controller. The second word defines which weight data the HI 4050WC should place in the Input Image Table for the PLC to read. The first word is not used. Ladder logic should not touch the first word if block transfers are used because the PLC uses the first word to control block transfers.

#### Structure of the Two Words in the PLC Output Image Table

	bits: 15-12	bits: 11-8	bits: 7-4	bits: 3-0
First Word of the Quarter	Not Used	Not Used	Not Used	Not Used
Second Word of the Quarter	bit shift	weight parameter	1st status byte	2nd status byte

**TABLE 4-1: DISCRETE WRITE - 2 WORDS (16 BITS EACH)**

#### Bit Shift

A number from 0 to 4 specifies the number of bits to shift the 16 bit window from the right of the internal 20 bit value. This sixteen bit window is the weight value that will be placed in the PLC Input Image Table. See the section on resolution for additional information. Once the sixteen bit value is read by the PLC, it can be multiplied by the factor shown below to yield the actual weight value.

0 = No shift, the lowest 16 bits are transferred.

1 = Shift one digit, multiply by 2 to achieve actual weight value

- 2 = Shift two digits, multiply by 4 to achieve actual weight value
- 3 = Shift three digits, multiply by 8 to achieve actual weight value
- 4 = Shift four digits, multiply by 16 to achieve actual weight value

### Weight Parameter

Select either Gross weight, Net weight, Rate-of-Change (mass flow), to be placed in the PLC Input Image Table.

#### NOTE

*All weight parameters are in the units (lbs., kgs.) used during calibration. Peak is not available.*

- 0 = Gross Weight (Standard)
- 1 = Net Weight (Standard)
- 2 = Rate-Of-Change (mass flow) (Optional)

### Status Byte

Select two of the status bytes below to be placed in the PLC Output Image Table. Definitions of the status bits contained in each status byte:

- 0 = Relay Status Byte
  - 1 = N/A
  - 2 = Indicator Group 2 Status Byte
  - 3 = Indicator Group 1 Status Byte
  - 4 = N/A
  - 5 = N/A
  - 6 = Acquire Tare (Set tare value = current gross weight)
  - 7 = N/A
  - 8 = MSB of 24 Bit Weight Value
  - 0-3 = 4 bits of weight data (16-19)
  - 4-7 = Sign Bits (20-23)
- 9 = Sync Pulse
  - 0 = Changes state every read (New data available)
  - 1 - 7 = Reserved

## Example

Placing a 0000 (Hex) for the first word and a 0123 (Hex) for the second word in the PLC Output Image Table will cause the HI 4050WC to place the least significant sixteen bits of the internal 20 bit net weight value and Indicator Groups 1 and 2 Status Bytes in the PLC Input Image Table.

## Discrete Writes in Mapping HI 4000 Series Compatibility

The Mapping mode is the same as any network communication except that discrete writes begin with word 64.

## Discrete Reads for HI 2151/30 Compatibility

The HI 4050WC places the weight and status information, specified in the last discrete write command, in the PLC Input Image Table. The data is arranged as shown in Table 4-2.

bits:	15-8	7-0
First Word of the Quarter	MSB of weight parameter	LSB of weight parameter
Second Word of the Quarter	1st Status Byte	2nd Status Byte

**TABLE 4-2: DISCRETE READ - 2 WORDS (16 BITS EACH)**

**NOTE** *Negative values are sent in “two’s complement form”.*

### 0 = Setpoint Status Byte

- bit 0 Not Used
- bit 1 Not Used
- bit 2 Not Used
- bit 3 Not Used
- bit 4 Setpoint #4 Status (on/off)
- bit 5 Setpoint #3 Status (on/off)
- bit 6 Setpoint #1 Status (on/off - Notice relays 1 & 2 are not in numerical sequence)
- bit 7 Setpoint #2 Status (on/off - Notice relays 1 & 2 are not in numerical sequence)

### 2 = Indicator Group 2 Status Byte

- bit 0 Weight currently displayed in pounds units

- bit 1 Zero Track Enabled
- bit 2 Not used
- bit 3 Current Gross Weight = 0
- bit 4 Weight in motion, i.e. changing
- bit 5 Gross Weight currently displayed
- bit 6 Net Weight currently displayed
- bit 7 Weight currently displayed in kilogram units

### 3 = Indicator Group 1 Status Byte

- bit 0 Rate-of-Change currently displayed
- bit 1 Setpoint Relay #2 active
- bit 2 Setpoint Relay #1 active
- bit 3 Not Used
- bit 4 Not Used
- bit 5 Not Used
- bit 6 Not Used
- bit 7 Not Used

**NOTE** *The PLC will receive both words with each discrete read, but it is not guaranteed that both words will be transferred as a unit. Both words will get transferred, but there may be some delay between the two.*

**NOTE** *For the PLC-2<sup>®</sup> series, you must use a 1772-SD2 scanner and the PLC-2<sup>®</sup> system to allow communication with the HI 4050WC via block transfer. Use block transfers only.*

**NOTE** *For the SLC 5/02<sup>®</sup> or above processors, you must use a 1747-SN to allow communication with the HI 4050WC via discrete transfer.*

### 8 = MSB of 24 Bit Weight Value

- bit 0 bit 16 of weight data
- bit 1 bit 17 of weight data
- bit 2 bit 18 of weight data
- bit 3 bit 19 of weight data
- bit 4 Bit 20
- bit 5 Bit 21
- bit 6 Bit 22
- bit 7 Bit 23





## Chapter 5 Block Transfers



### About Block Transfers

The ladder logic programmer is able to exchange blocks of data with an all-sizes rack device via Block Transfer instructions in the ladder logic program. A Write Block Transfer is used to send commands and data to the Weight Controller, and a Read Block Transfer is used to collect acknowledgments and data from the Weight Controller.

To utilize 20 bit resolution, the Ladder Logic program must synchronize the use of Block Transfer data to insure block integrity. Synchronization is accomplished by not using block data between the time block transfer is enabled and done (EN and DN bits). Of course, data can be moved to another buffer where it can be accessed while the next block transfer is in progress. The structure of the four byte numeric format for all weight parameters except totalized weight is as follows:

BYTE 1	BYTE 0 upper 4 bits	Byte 0 lower 4 bits	BYTE 3	BYTE 2
Sign bits	Sign bits (all 1's or 0's)	Weight bits 19-16	Weight bits 15-8	Weight bits 7-0

**TABLE 5-3: FOUR BYTE NUMERIC FORMAT FOR WEIGHT PARAMETERS**

**NOTE** *The most significant word is located before the least significant word in the block I/O transfer.*

**NOTE** *Negative values are sent in "two's complement" form.*

**NOTE** *The Maximum block size is 63 words.*

## /30 Mode

Totalized weight uses all 32 bits available in the two words to represent unsigned data. The block transfer commands and formats are listed in the following tables. The Block Read commands are followed by the Block Write commands. When writing information to the weight controller be sure to send zeros (0's) to all words and bits marked as "reserved for future use". This will aid in achieving upward compatibility to future enhancements to the command set. For additional information on the function of each parameter in the tables below, consult the HI 2151 Installation and Operation manuals.

### Block Read Commands

All block read commands are initiated by the ladder logic program performing a block write to the weight controller with the desired block command number in the first byte position of the block. The PLC then performs a block read and the weight controller will return the desired information with the read command number repeated in the first byte of the block returned. If a data error is detected, an error code "99" is in the first byte of the returned block.

**NOTE** *All block reads are initiated by performing a block write.*

**NOTE** *A returned value of "99" (decimal) indicates an error.*

## Mapping Mode

**NOTE** *No block write needed for HI 4000 Series mapping mode before doing a block read. Block read instruction will get all data mapped into the output words 0-62.*



## Block Read Command Number 1: Full Status and Weight Data

BLOCK READ COMMAND NUMBER 1: Full status and weight data		
WORD DEFINITIONS:	#WORDS	START WORD
<p>Command number: A value of 1 (decimal)</p> <ul style="list-style-type: none"> <li>bit 0     1</li> <li>bit 1     0</li> <li>bit 2     0</li> <li>bit 3     0</li> <li>bit 4     0</li> <li>bit 5     0</li> <li>bit 6     0</li> <li>bit 7     0</li> </ul> <p>Indicator Group 1 Status</p> <ul style="list-style-type: none"> <li>bit 8     Rate-of-Change currently displayed</li> <li>bit 9     Setpoint RElay #2 active</li> <li>bit 10    Setpoint Relay #1 active</li> <li>bit 11    Peak Force (weight) currently displayed</li> <li>bit 12    Totalized weight currently displayed</li> <li>bit 13    Reserved for future use</li> <li>bit 14    Reserved for future use</li> <li>bit 15    Reserved for future use</li> </ul>	1	0
<p>Indicator Group 2 Status</p> <ul style="list-style-type: none"> <li>bit 0     Weight currently displayed in pounds units</li> <li>bit 1     Zero Track feature enabled</li> <li>bit 2     Reserved for future use</li> <li>bit 3     Current gross weight = 0</li> <li>bit 4     Weight in motion, i.e. changing</li> <li>bit 5     Gross weight currently displayed</li> <li>bit 6     Net weight currently displayed</li> <li>bit 7     Weight currently displayed in Kilogram units</li> </ul> <p>Dipswitch Settings (exterior) Status</p> <ul style="list-style-type: none"> <li>bit 8     Not Used</li> <li>bit 9     Not Used</li> <li>bit 10    Not Used</li> <li>bit 11    Not Used</li> <li>bit 12    Not Used</li> <li>bit 13    Not Used</li> <li>bit 14    Not Used</li> <li>bit 15    Not Used</li> </ul> <p><i>Note: When the HI 2151WC is configured as a blind unit, the status of the dipswitches are not visible. See section on blind operation for more information.</i></p>	1	1

**TABLE 5-4: BLOCK READ COMMAND NUMBER 1: FULL STATUS AND WEIGHT DATA**

BLOCK READ COMMAND NUMBER 1: Full status and weight data		
WORD DEFINITIONS:	#WORDS	START WORD
Dipswitch Settings (interior) Status bit 0      Not Used bit 1      Not Used bit 2      Not Used bit 3      Not Used bit 4      Not Used bit 5      Not Used bit 6      Not Used bit 7      Not Used Remote Function Status bit 8      Not Used bit 9      Not Used bit 10     Not Used bit 11     Not Used bit 12     Not Used bit 13     Not Used bit 14     Not Used bit 15     Not Used	1	2
Rate-of-Change Not Used Not Used Gross Weight Net Weight Tare Value  <i>Note: All weight data is in the units (lbs., kgs.) which were used at the time of calibration.</i>	2 2 2 2 2 2	3 5 7 9 11 13
TOTAL NUMBER OF WORDS	15	

**TABLE 5-4: BLOCK READ COMMAND NUMBER 1: FULL STATUS AND WEIGHT DATA**

## Block Read Command Number 2: Setpoint Relay Parameter

BLOCK READ COMMAND NUMBER 2: Setpoint Relay Parameters		
WORD DEFINITIONS:	#WORDS	START WORD
Command number: A value of 2 (decimal) bit 0        0 bit 1        1 bit 2        0 bit 3        0 bit 4        0 bit 5        0 bit 6        0 bit 7        0 Indicator Group 2 Status bit 8        Weight currently displayed in pounds units bit 9        Zero Track feature enabled bit 10       Reserved for future use bit 11       Current gross weight = 0 bit 12       Weight in motion, i.e. changing bit 13       Gross weight currently displayed bit 14       Net weight currently displayed bit 15       Weight currently displayed in kilogram units  Note: A returned value of "99" (decimal) indicates an error.	1	0
Relay Status bit 0        Not Used bit 1        Not Used bit 2        Not Used bit 3        Not Used bit 4        Relay #4 status (on/off) bit 5        Relay #3 status (on/off) bit 6        Relay #1 status (on/off) bit 7        Relay #2 status (on/off) bit 8 - 15   Setpoint description byte A (See Table 5-4 & 5-5)	1	1
bits 0-7    Setpoint description byte B (See Table 5-4 & 5-5) bits 8-15   Setpoint description byte C (See Table 5-4 & 5-5)	1	2
Deadband value for setpoint #1 Deadband value for setpoint #2 Deadband value for setpoint #3 Deadband value for setpoint #4 Not Used Not Used Not Used Not Used	2 2 2 2 2 2 2 2	3 5 7 9 11 13 15 17

BLOCK READ COMMAND NUMBER 2: Setpoint Relay Parameters		
WORD DEFINITIONS:	#WORDS	START WORD
Preact value for setpoint #1	2	19
Preact value for setpoint #2	2	21
Preact value for setpoint #3	2	23
Preact value for setpoint #4	2	25
Not Used	2	27
Not Used	2	29
Not Used	2	31
Not Used	2	33
Setpoint value for setpoint #1	2	35
Setpoint value for setpoint #2	2	37
Setpoint value for setpoint #3	2	39
Setpoint value for setpoint #4	2	41
Not Used	2	43
Not Used	2	45
Not Used	2	47
Not Used	2	49
TOTAL NUMBER OF WORDS	51	

**TABLE 5-5: BLOCK READ COMMAND NUMBER 2: SETPOINT RELAY PARAMETERS**

### About Set Points

The set point value is the target weight or level. It may be set in either net or gross weight units.

### Set Point Limits

#### Dead Band Limits

- The Dead Band limit is the difference between the set point and the relay reset.
- The dead band value under normal operations will always be a positive value however the dead band value can be set as a negative value should your application require it. Dead Band limits are used to prevent relay chatter once the set point is reached.
- For example: If a set point value was 1000 pounds and the dead band was set to 5 pounds, the relay would close at 1000 pounds but not open until the weight dropped to 995 pounds. You need to select the Type: Loss in Weight. This would be used if a set point is a high trip limit. Selecting the Type: Gain in Weight and dead band would be used for a low trip limit. Examples are show for Low and High Trip Limits. (See Figs. 26 & 27)

#### Three General Rules for Set Points

- 1 Set points activate at the set point plus the preact.**
- 2 Set points deactivate at the set point plus the deadband.**

- 3 The deadband should be numerically larger than the preact to prevent relay chatter.

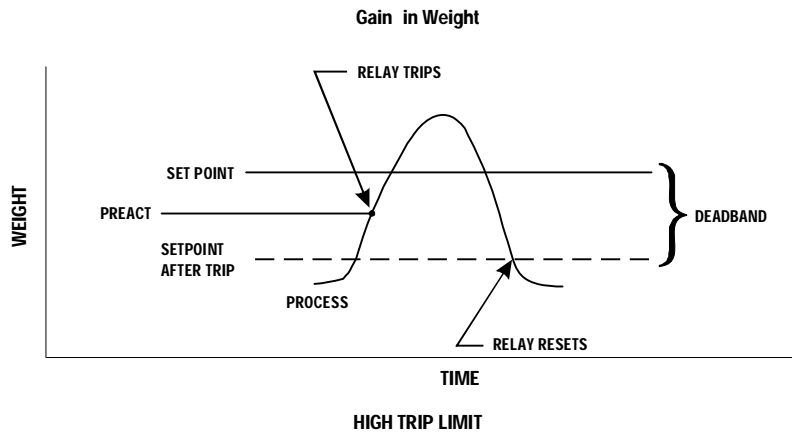


FIG. 27 GAIN IN WEIGHT/HIGH TRIP LIMIT

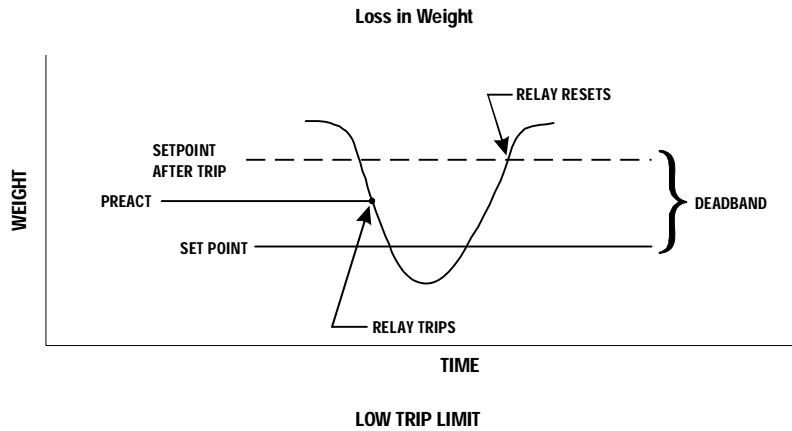


FIG. 28 LOSS IN WEIGHT/LOW TRIP LIMIT

### Preact Limits

- The preact value is the difference between the set point and the trip point.
- It is used as an “in-flight” compensation value when filling a vessel. If set to zero, there will be no compensation.

### Mode

Specifies which weight source is used as the set point input.

## Type

Determines whether the set point turns on when the weight is greater than the set point **target** minus the **preact** and off when the weight is less than the target minus the deadband (Gain in Weight) or if it turns on when the weight is less than the set point target plus the preact and off when the weight is greater than the set point minus the preact (Loss in Weight)

	Peak Force	Net Weight	Gross Weight	Rate-of-Change	Totalizer
Word 1, bits 8 - 15	0	0	0	0	1
Word 2, bits 0 - 7	0	0	1	1	0
Word 2, bits 8 - 15	0	1	0	1	0

**TABLE 5-6: SETPOINT DESCRIPTION BYTES**

The three setpoint description bytes are constructed by first reading the table above to determine the 1 and 0 pattern representing the weighing parameter you would like the setpoint to monitor, then writing that pattern below under the appropriate relay number. When patterns have been written for all desired relays then read bytes A, B, and C across from left to right.

SETPOINT DESCRIPTION BYTES								
	SP 8	SP 7	SP 6	SP 5	SP 4	SP 3	SP 2	SP 1
Word 1, bits 8-15								
Word 2, bits 0-7								
Word 2, bits 8-15								

**TABLE 5-7: SETPOINT DESCRIPTION BYTES**

## Example of Proper Setpoint Description Bytes

The proper setpoint description bytes for the following desired Relay types are as follows:

Relay 1 = GrossWord 1, bits 8 - 15 = 0001 0000 = 10 (hex)

Relay 2 = NetWord 2, bits 0 - 7 = 1110 0101 = E5 (hex)

Relay 3 = Rate-of-ChangeWord 2, bits 8 - 15 = 0000 0110 = 06 (hex)

Relay 4 = Peak

Relay 5 = Totalizer

Relay 6 = Gross

Relay 7 = Gross

Relay 8 = Gross

### Block Read Command Number 3: Instrument Identification and Diagnostics

BLOCK READ COMMAND NUMBER 3: Instrument Identification and Diagnostics		
WORD DEFINITIONS:	#WORDS	START WORD
Command number: A value of 3 (decimal) bit 0      1 bit 1      1 bit 2      0 bit 3      0 bit 4      0 bit 5      0 bit 6      0 bit 7      0  Instrument type by model number bit 8      Not Used bit 9-15   Not Used	1	0
Firmware revision level: (ASCII format, i.e. 65 = A)	1	1
Zero calibration analog to digital converter raw counts:	2	2
Analog to digital converter raw counts:	2	4
TOTAL NUMBER OF WORDS	6	

**TABLE 5-8: BLOCK READ COMMAND NUMBER 3: INSTRUMENT IDENTIFICATION AND DIAGNOSTICS**

## Block Read Command Number 4: Read Tare Value

BLOCK READ COMMAND NUMBER 4: Read Tare Value		
WORD DEFINITIONS:	#WORDS	START WORD
Command number: A value of 4 (decimal) bit 0      0 bit 1      0 bit 2      1 bit 3      0 bit 4      0 bit 5      0 bit 6      0 bit 7      0 bits 8 - 15   Not Used	1	0
Tare Value	2	1
TOTAL NUMBER OF WORDS	3	

**DEFAULT: BLOCK READ COMMAND NUMBER 4: READ TARE VALUE**

## Block Read Command Number 5: Calibration Parameters

BLOCK READ COMMAND NUMBER 5: Calibration Parameters		
WORD DEFINITIONS:	#WORDS	START WORD
Command number: A value of 5 (decimal) bit 0      1 bit 1      0 bit 2      1 bit 3      0 bit 4      0 bit 5      0 bit 6      0 bit 7      0 bits 8 - 15   Not Used	1	0
Units of Measure bits 0 - 7    A value of 0 for pounds, or 1 for kilograms Decimal point position (places to the right of the decimal) bits 8 - 15   A value from 0 to 5	1	1



BLOCK READ COMMAND NUMBER 5: Calibration Parameters		
WORD DEFINITIONS:	#WORDS	START WORD
Totalizer decimal point position (places to the right of the decimal) bis 0 - 7 A value from 0 to 5 C2™, Second Generation Calibration bits 8 - 15 Load Cell Count	1	2
Display Graduation size ('count by): A value of 1,2,5,10,20,50,100,200, 500 or 1000	1	3
Motion Tolerance: A sixteen bit value representing the low 16 bits of the 20 bit internal weighing range	1	4
Zero Tolerance: A sixteen bit value representing the low 16 bits of the 20 bit internal weighing range	1	5
Number of readings averaged: A value from 1 to 255	1	6
Reference Weight	2	7
Scale Capacity	2	9
Span Weight	2	11
TOTAL NUMBER OF WORDS	13	

**TABLE 5-9: BLOCK READ COMMAND NUMBER 5: CALIBRATION PARAMETERS**

**NOTE**

*The Span Value has moved from word 7 to word 11. The Midpoint linearity correction does not exist in the HI 4050.*

**Block Read Command Number 6: Configuration of Rate-of-Change**

BLOCK READ COMMAND NUMBER 6: Configuration of Rate-of-Change		
WORD DEFINITIONS:	#WORDS	START WORD
Command number: A value of 6 (decimal) bit 0 0 bit 1 1 bit 2 1 bit 3 0 bit 4 0 bit 5 0 bit 6 0 bit 7 0 bits 8 - 15 Reserved for future use	1	0
Displayed Rate-of-Change time units: A value of 0 to 2 (0=sec, 1=min, 2=hr)	1	1

BLOCK READ COMMAND NUMBER 6: Configuration of Rate-of-Change		
WORD DEFINITIONS:	#WORDS	START WORD
Rate-of-Change timebase evaluation period in seconds 0 = 1 second    4 = 5 seconds    8 = 15 seconds    12 = 240 seconds 1 = 2 seconds    5 = 6 seconds    9 = 30 seconds    13 = 450 seconds 2 = 3 seconds    6 = 10 seconds    10 = 60 seconds    14 = 900 seconds 3 = 4 seconds    7 = 12 seconds    11 = 120 seconds    15 = 1800 seconds	1	2
TOTAL NUMBER OF WORDS	3	

**TABLE 5-10: BLOCK READ COMMAND NUMBER 6: CONFIGURATION OF RATE-OF-CHANGE**

**NOTE**

*In the /30 compatibility mode when making adjustments from the front panel you must use the Rate-of-Change timebase table. All other values are rounded down to the nearest table value. For example if you enter 20 seconds as the Rate-of-Change Timebase evaluation period it will be read as the index number 8 not 15 or 20 seconds.*

**Block Read Command Number 7: BCD Output Configuration**

BLOCK READ COMMAND NUMBER 7: BCD Output Configuration		
WORD DEFINITIONS:	#WORDS	START WORD
Command number: A value of 7 (decimal) bit 0        1 bit 1        1 bit 2        1 bit 3        0 bit 4        0 bit 5        0 bit 6        0 bit 7        0  Format of output bit 8        If set, will update BCD output when "print" button or remote function is activated bit 9        Reserved for future use bit 10       If set, will output weight data currently displayed bit 11       If set, will output tare value bit 12       If set, will output net weight bit 13       If set, will output gross weight bit 14-15   Reserved for future use	1	0
Reserved for future use	1	1

BLOCK READ COMMAND NUMBER 7: BCD Output Configuration		
WORD DEFINITIONS:	#WORDS	START WORD
TOTAL NUMBER OF WORDS	2	

**TABLE 5-11: BLOCK READ COMMAND NUMBER 7: BCD OUTPUT CONFIGURATION**

**Block Read Command Number 8: Configuration of Analog Output**

BLOCK READ COMMAND NUMBER 8: Configuration of Analog Output		
WORD DEFINITIONS:	#WORDS	START WORD
Command number: A value of 8 (decimal) bit 0        0 bit 1        0 bit 2        0 bit 3        1 bit 4        0 bit 5        0 bit 6        0 bit 7        0  Weight parameter to be transmitted bits 8 - 15 A value from 0 to 4 (0 = Gross, 1 = Net, 2 = Rate-of-Change, 3 = Peak Force, 4 = Totalize amount)	1	0
Weight value represented by a zero scale analog output:	2	1
Weight value represented by a full scale analog output:	2	3
TOTAL NUMBER OF WORDS	5	

**TABLE 5-12: BLOCK READ COMMAND NUMBER 8: CONFIGURATION OF ANALOG OUTPUT**

## Block Read Command Number 11: Auto Zero Tolerance

BLOCK READ COMMAND NUMBER 11: Auto Zero Tolerance		
WORD DEFINITIONS:	#WORDS	START WORD
Command number: A value of 11 (decimal) bit 0        1 bit 1        1 bit 2        0 bit 3        1 bit 4        0 bit 5        0 bit 6        0 bit 7        0 bits 8 - 15   Reserved for future use	1	0
Auto Zero Tolerance A 16 bit number in proper integer format	1	1
TOTAL NUMBER OF WORDS	2	

**TABLE 5-13: BLOCK READ COMMAND NUMBER 11: AUTO ZERO TOLERANCE**

## Block Read Command Number 12: Integrated Technician

BLOCK READ COMMAND NUMBER 12: Integrated Technician		
WORD DEFINITIONS:	#WORDS	START WORD
Command number: A value of 12 (decimal) bit 0        0 bit 1        0 bit 2        1 bit 3        1 bit 4        0 bit 5        0 bit 6        0 bit 7        0 bit 8        Reserved for future use	1	0

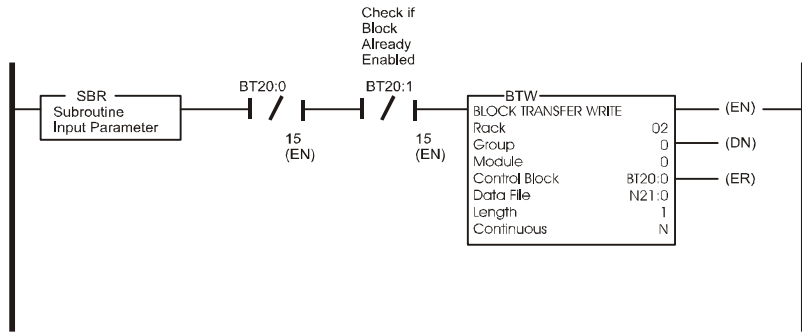
BLOCK READ COMMAND NUMBER 12: Integrated Technician		
WORD DEFINITIONS:	#WORDS	START WORD
Excitation Monitor  On/Off bits 0 - 7    A value of 0 or 1 (0 = Off, 1 = On)  OK/ERR bits 8 - 15    A value of 0 or 1 (0 = OK, 1 = ERR)	1	1
TOTAL NUMBER OF WORDS	2	

**TABLE 5-14: BLOCK READ COMMAND NUMBER 12: INTEGRATED TECHNICIAN**

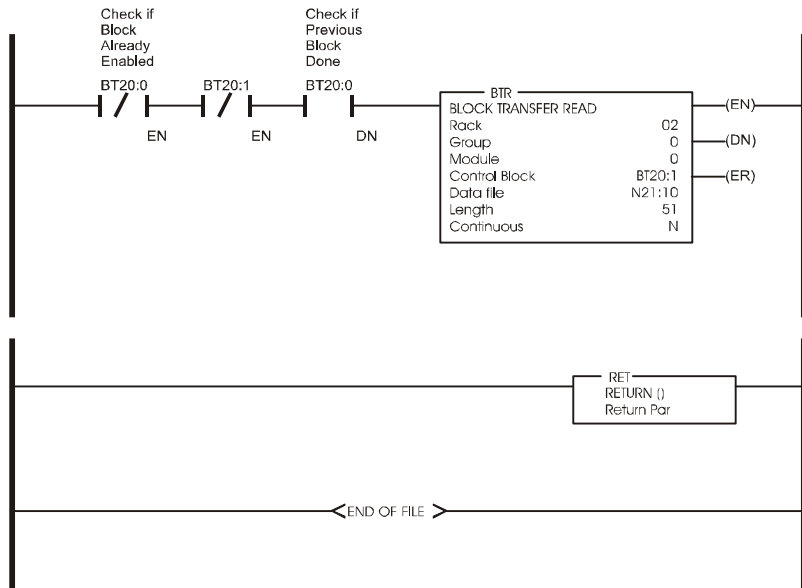
### Block Transfer Read Example

This routine is set up to be used with the HI 4050WC series weight controllers. It is a Block Transfer Read (BTR) sub-routine, currently configured to do a BTR 2 of the relay setpoint data. The block length is the only value which needs to be changed to use other block transfer read types. This routine will continually read the HI 4050WC as long as it is running.

N21:0 will have a 2, to request a block transfer read #2.



Read the data requested from the HI 2151



**FIG. 29 BLOCK TRANSFER READ EXAMPLE**

# Block Write Commands

## About Block Write Commands

After the PLC performs a block transfer write, a block read should be performed to evaluate the response code from the HI 4050 to verify that the data was received and implemented. The response word will either show a successful processing of the block or will indicate the first error encountered in processing of the data.

**NOTE** *Setpoints, deadbands and preacts can all accept negative values. To enter negative values, use the “twos complement” method.*

**NOTE** *Block Writes cannot be performed while the instrument is in calibration mode. The calibration must be sealed by pressing enter at Endcal.*

## Block Write Command Number 51: Activate Scale Functions

BLOCK WRITE COMMAND NUMBER 51: Activate Scale Functions		
WORD DEFINITIONS:	#WORDS	START WORD
Command number: A value of 51 (decimal) bit 0        1 bit 1        1 bit 2        0 bit 3        0 bit 4        1 bit 5        1 bit 6        0 bit 7        0  Remote Functions Byte bit 8        Acquire TARE (Set tare value = current gross weight)* bit 9        Initiates print on standard RS232* bit 10       Add current Net weight to Total* <sup>!</sup> bit 11       Clear Peak Hold register* <sup>!</sup> bit 12       Clear Totalizer Accumulation* <sup>!</sup> bit 13       Zero the instrument* bit 14       Enable Zero Tracking (Blind Unit Only) bit 15       Reserved for future use  *Note: The bit must be toggled to activate this function !Note: Only active if the instrument is ordered with this option	1	0
TOTAL NUMBER OF WORDS	1	

**TABLE 5-15: BLOCK WRITE COMMAND NUMBER 51: ACTIVATE SCALE FUNCTIONS**

**Block Write Command Number 52: Downloading Setpoint Relay Parameters**

BLOCK WRITE COMMAND NUMBER 52: Downloading Setpoint Relay Parameters		#WORDS	START WORD
WORD DEFINITIONS:			
Command number: A value of 52 (decimal)		1	0
bit 0	0		
bit 1	0		
bit 2	1		
bit 3	0		
bit 4	1		
bit 5	1		
bit 6	0		
bit 7	0		
bits 8 - 15	Not Used		
Setpoint Enable:			
bit 8	Enable Relay #8 to evaluate weight		
bit 9	Enable Relay #7 to evaluate weight		
bit 10	Enable Relay #6 to evaluate weight		
bit 11	Enable Relay #5 to evaluate weight		
bit 12	Enable Relay #4 to evaluate weight		
bit 13	Enable Relay #3 to evaluate weight		
bit 14	Enable Relay #1 to evaluate weight*		
bit 15	Enable Relay #2 to evaluate weight*		
*Note: Notice relays 1 and 2 are not in numerical sequence			
Force Relay Status*		1	1
bit 0	Not Used		
bit 1	Not Used		
bit 2	Not Used		
bit 3	Not Used		
bit 4	Not Used		
bit 5	Not Used		
bit 6	Not Used		
bit 7	Not Used		
bits 8 - 15	Setpoint description byte A (See Table 5-15 & 5-16)		
bits 0 - 7	Setpoint description byte B (See Table 5-15 & 5-16)	1	2
bits 8 - 15	Setpoint description byte C (See Table 5-15 & 5-16)		



BLOCK WRITE COMMAND NUMBER 52:Downloading Setpoint Relay Parameters		
WORD DEFINITIONS:	#WORDS	START WORD
Deadband value for setpoint #1	2	3
Deadband value for setpoint #2	2	5
Deadband value for setpoint #3	2	7
Deadband value for setpoint #4	2	9
Not Used	2	11
Not Used	2	13
Not Used	2	15
Not Used	2	17
Preact value for setpoint #1	2	19
Preact value for setpoint #2	2	21
Preact value for setpoint #3	2	23
Preact value for setpoint #4	2	25
Not Used	2	27
Not Used	2	29
Not Used	2	31
Not Used	2	33
Setpoint value for setpoint #1	2	35
Setpoint value for setpoint #2	2	37
Setpoint value for setpoint #3	2	39
Setpoint value for setpoint #4	2	41
Not Used	2	43
Not Used	2	45
Not Used	2	47
Not Used	2	49
TOTAL NUMBER OF WORDS	51	

**TABLE 5-16: BLOCK WRITE COMMAND NUMBER 52: DOWNLOADING SETPOINT RELAY PARAMETERS**

**NOTE** *Deadband must be numerically larger than preact.*

	Net Weight	Gross Weight	Rate-of-Change
Word 1, bits 8 - 15	0	0	0
Word 2, bits 0 - 7	0	1	1
Word 2, bits 8 - 15	1	0	1

**TABLE 5-17: SETPOINT DESCRIPTION BYTES**

The three setpoint description bytes are constructed by first reading the table above to determine the 1 and 0 pattern representing the weighing parameter you would like the setpoint to monitor, then writing that pattern below under the appropriate relay number. When patterns have been written for all desired relays then read bytes A, B, and C across from left to right.

SETPOINT DESCRIPTION BYTES								
	Setpoint 8	Setpoint 7	Setpoint 6	Setpoint 5	Setpoint 4	Setpoint 3	Setpoint 2	Setpoint 1
Word 1, bits 8-15	Not Used	Not Used	Not Used	Not Used				
Word 2, bits 0-7	Not Used	Not Used	Not Used	Not Used				
Word 2, bits 8-15	Not Used	Not Used	Not Used	Not Used				

**TABLE 5-18: SETPOINT DESCRIPTION BYTES**

### Example of Proper Setpoint Description Bytes

The proper setpoint description bytes for the following desired Relay types are as follows:

Setpoint 1 = Gross

Setpoint 2 = Net

Setpoint 3 = Rate-of-Change

Word 1, bits 8 - 15 = 0001 0000 = 10 (hex)

Word 2, bits 0 - 7 = 1110 0101 = E5 (hex)

Word 2, bits 8 - 15 = 0000 0110 = 06 (hex)

## Block Write Command Number 53: Send Tare Value

BLOCK WRITE COMMAND NUMBER 53:Send Tare Value		
WORD DEFINITIONS:	#WORDS	START WORD
Command number: A value of 53 (decimal) bit 0        1 bit 1        0 bit 2        1 bit 3        0 bit 4        1 bit 5        1 bit 6        0 bit 7        0 bit 8 -15   Not Used	1	0
Tare Value	2	1
TOTAL NUMBER OF WORDS	3	

**TABLE 5-19: BLOCK WRITE COMMAND NUMBER 53: SEND TARE VALUE**

## Block Write Command Number 54: Scale Calibration Action

BLOCK WRITE COMMAND NUMBER 54: Scale Calibration Action		
WORD DEFINITIONS:	#WORDS	START WORD
Command number: A value of 54 (decimal) bit 0      0 bit 1      1 bit 2      1 bit 3      0 bit 4      1 bit 5      1 bit 6      0 bit 7      0  Remote Functions Byte bit 8      Cal Low bit 9      Setting this bit tells the instrument that current weight is span weight.  bit 10     Save. bit 11     Not Used bit 12     Not Used bit 13     Not Used bit 14     Setting this bit tells the instrument that current weight is the C2™ reference point. bit 15     Not Used	1	0
TOTAL NUMBER OF WORDS	1	

**TABLE 5-20: BLOCK WRITE COMMAND NUMBER 54: SCALE CALIBRATION ACTION**

## Block Write Command Number 55: Calibration Parameters

BLOCK WRITE COMMAND NUMBER 55: Calibration Parameters		
WORD DEFINITIONS:	#WORDS	START WORD
Command number: A value of 55 (decimal) bit 0        1 bit 1        1 bit 2        1 bit 3        0 bit 4        1 bit 5        1 bit 6        0 bit 7        0 bit 8 - 15   Not Used	1	0
Units of Measure: bits 0 - 7    0 = pounds, 1 = kilograms Decimal point position (places to right of decimal): bits 8 - 15   A value from 0 to 4	1	1
bits 0 - 7    Not Used bits 8 - 15   Not Used	1	2
Display Graduation Size ("count by"): A value of 1,2,5,10,20,50,100,200 or 500	1	3
Motion Tolerance: A sixteen bit value representing the lower 16 bits of the 20 bit internal weighing range	1	4
Zero Tolerance: A sixteen bit value representing the lower 16 bits of the 20 bit internal weighing range	1	5
Number of readings averaged: A value from 1 to 200	1	6
Reference Weight	2	7
Scale Capacity (Full limit of scale): A 20 bit number in proper integer format	2	9
Span weight value (Use one of the following methods. Method one, with C2, Second Generation Calibration: Use the C2 reference point when using C2 load cells. Method two: use test weights for calibration) A 20 bit number in proper integer format	2	11
TOTAL NUMBER OF WORDS	13	

**TABLE 5-21: BLOCK WRITE COMMAND NUMBER 55: CALIBRATION PARAMETERS**

## Block Write Command Number 56: Configuration of Rate-of-Change

BLOCK WRITE COMMAND NUMBER 56: Configuration of Rate-of-Change		
WORD DEFINITIONS:	#WORDS	START WORD
Command number: A value of 56 (decimal) bit 0        0 bit 1        0 bit 2        0 bit 3        1 bit 4        1 bit 5        1 bit 6        0 bit 7        0 bit 8 - 15   Reserved for future use	1	0
Displayed Rate-of-Change time units: A value of 0 to 2 (0 = sec, 1 = min, 2 = hr)	1	1
Rate-of-Change timebase evaluation period: A value of 0 to 15 from list below: 0 = 1 second    4 = 5 seconds    8 = 15 seconds    12 = 240 seconds 1 = 2 seconds    5 = 6 seconds    9 = 30 seconds    13 = 450 seconds 2 = 3 seconds    6 = 10 seconds    10 = 60 seconds    14 = 900 seconds 3 = 4 seconds    7 = 12 seconds    11 = 120 seconds    15 = 1800 seconds	1	2
<b>TOTAL NUMBER OF WORDS</b>	3	

**TABLE 5-22: BLOCK WRITE COMMAND NUMBER 56: CONFIGURATION OF RATE-OF-CHANGE**

## Block Write Command Number 61: Auto Zero Tolerance

BLOCK WRITE COMMAND NUMBER 61: Auto Zero Tolerance		
WORD DEFINITIONS:	#WORDS	START WORD
Command number: A value of 61 (decimal) bit 0        1 bit 1        0 bit 2        1 bit 3        1 bit 4        1 bit 5        1 bit 6        0 bit 7        0 bits 8 - 15 Not Used	1	0
Auto Zero Tolerance A 16 bit number in proper integer format	1	1
TOTAL NUMBER OF WORDS	2	

**TABLE 5-23: BLOCK WRITE COMMAND NUMBER 61: AUTO ZERO TOLERANCE**

## Block Write Command Number 62: Waversaver/Excitation Monitor

BLOCK WRITE COMMAND NUMBER 62: Waversaver/Excitation Monitor		
WORD DEFINITIONS:	#WORDS	START WORD
Command number: A value of 62 (decimal) bit 0        0 bit 1        1 bit 2        1 bit 3        1 bit 4        1 bit 5        1 bit 6        0 bit 7        0  Waversaver bits 8 - 15 Waversaver setting (1-5) (Error #87 returned if an error)	1	0

BLOCK WRITE COMMAND NUMBER 62: Waversaver/Excitation Monitor		
WORD DEFINITIONS:	#WORDS	START WORD
Excitation Monitor bit 0        Not Used bits 1 - 15   Not Used	1	1
TOTAL NUMBER OF WORDS	2	

**TABLE 5-24: BLOCK WRITE COMMAND 62: WAVERSAVER/EXCITATION MONITOR**

**Block Transfer Write Example**

This is a Block Transfer Write (BTW) sub-routine, currently configured to do a BTW 52 of the relay setpoint data. The block length is the only value which needs to be changed to use other block transfer write types. Once called, the routine will write the block until a return code of 06 (BTW OK) is sent.

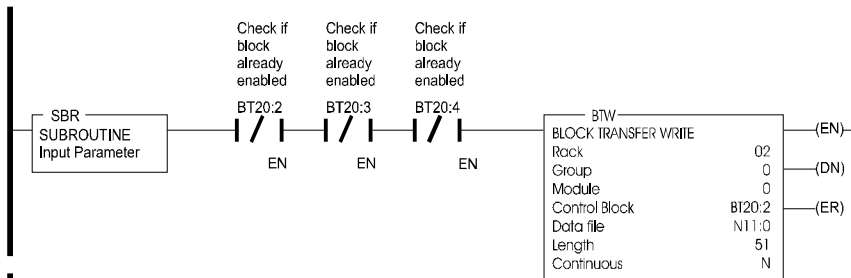
A value of 70 is at N 11:60

B 3:0 will enable routine and is cleared when completed

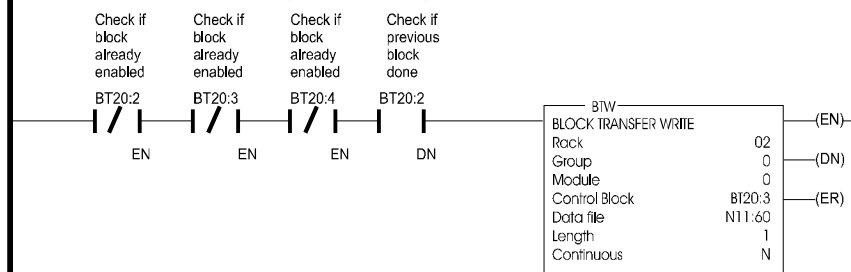
Valid BTW Data starts at N 11:0



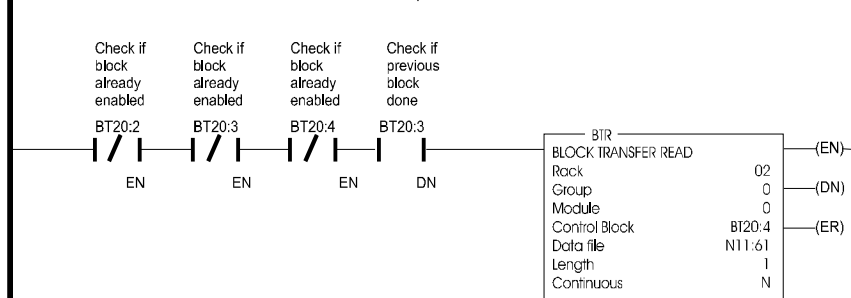
Write the data to the HI 2151



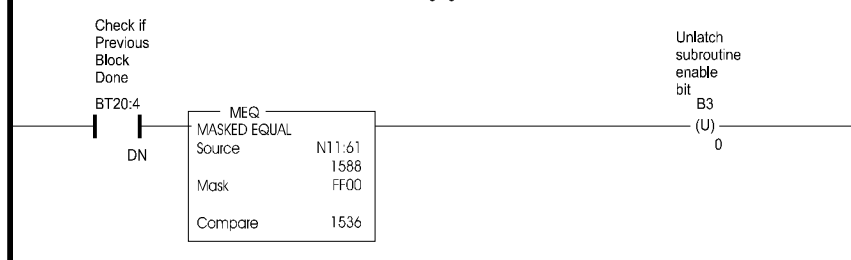
Request the status of the previous write to the HI 2151



Read the status requested from the HI 2151



Check for acknowledge good data received



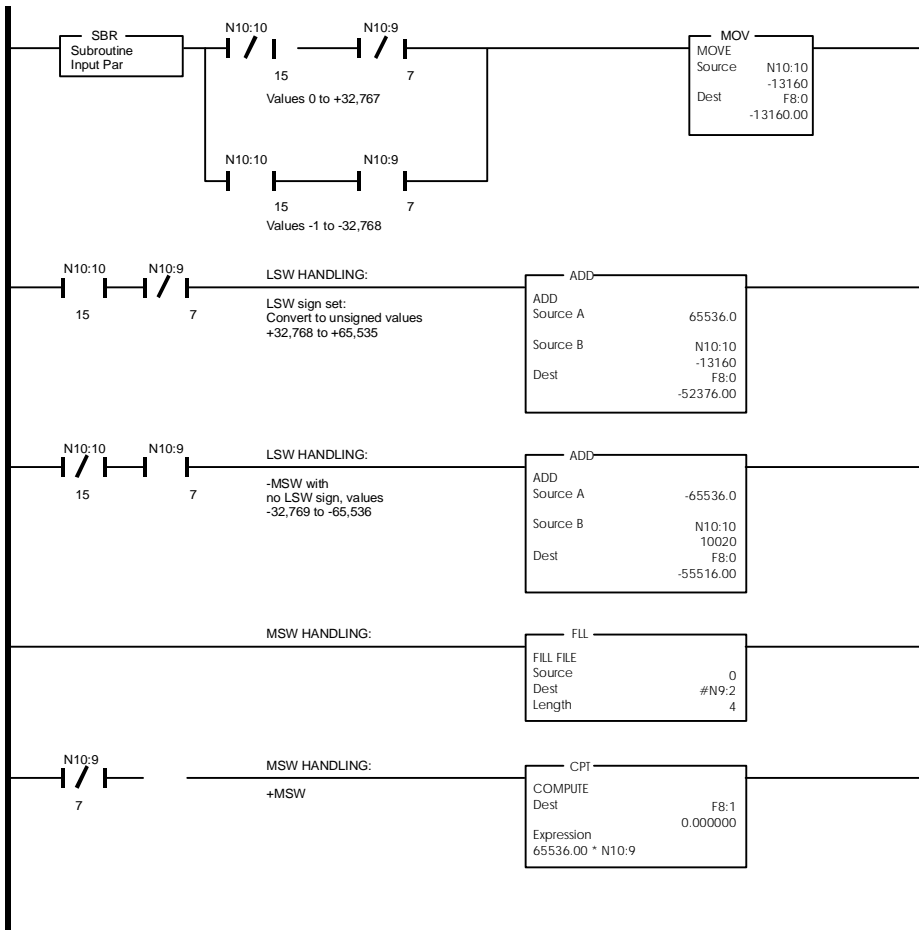
block transfer write example

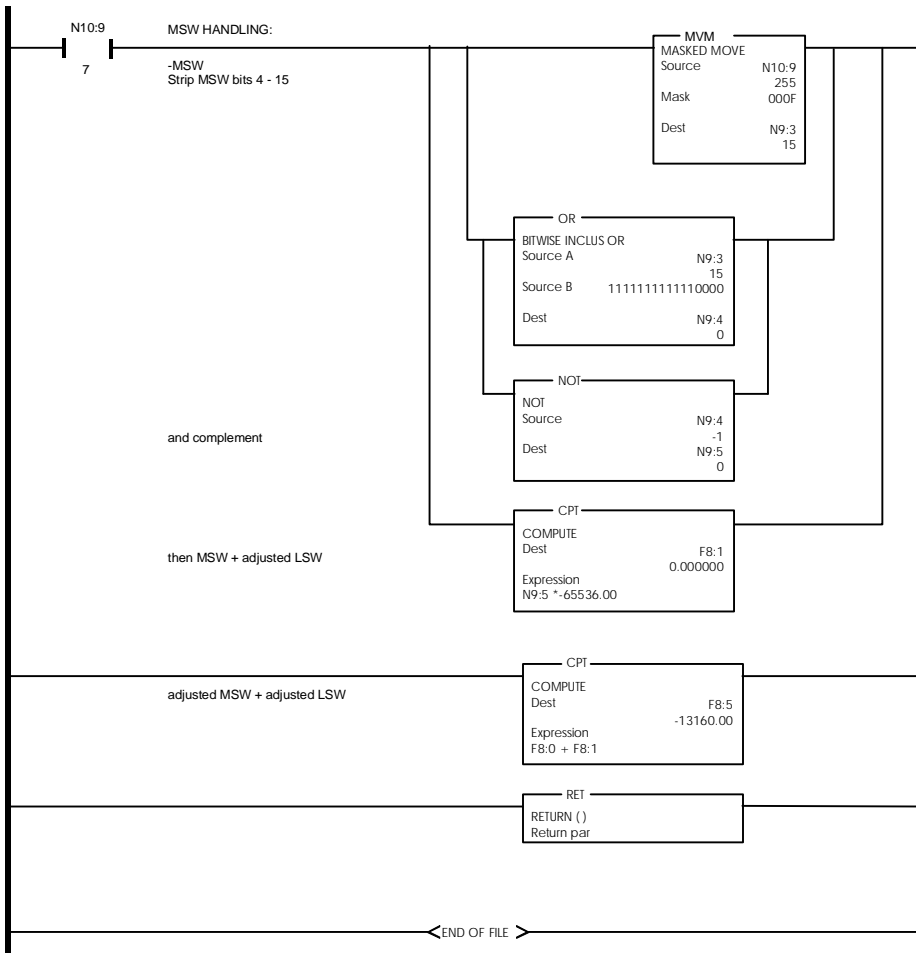
## Integer to Floating Point Routine

This example assumes the two words representing the desired weight value have been read with a block transfer read. They must also reside as MSW in memory location N10:9, and as LSW in memory location N10:10. This routine works for all values except the totalizer.

### NOTE

*All negative numbers are sent from the weight controller to the programmable controller in "twos complements"*





**FIG. 30 INTEGER TO FLOATING POINT ROUTINE**

## Response and Error Codes

Each time the PLC performs a block write, it should then perform the response code block read. This block read will return two bytes. The first byte is the command number of the last block write performed. The second byte will be the response or error code returned. If the error code is a NACK (21) then the returned command number will be a 99

BLOCK READ COMMAND NUMBER 70: Reading response code after a block write		
WORD DEFINITIONS	# WORDS	START WORD
Write command number (not 70 but the command number of the write performed) Bits 0 - 7	1	0
Response code from table below Bits 8-15		
TOTAL NUMBER OF WORDS	1	

**TABLE 5-25: BLOCK READ COMMAND NUMBER 70: READING RESPONSE CODE AFTER A BLOCK WRITE**

## Block Read or Block Write Error Codes

Decimal	HEX	Description
06	06	Acknowledge good data received
21	15	NACK - illegal command

### Block Write Error Codes

49	31	Scale in motion (for example: unable to calibrate while in motion)
51	33	Weight not within zero tolerance, unable to zero
52	34	Insufficient change in weight to calibrate span
53	35	Decimal point places must be between 0 and 4
54	36	Not a valid graduation size
55	37	Motion value must be greater than graduation size
56	38	Zero tolerance value must be greater than 0 and positive.
57	39	Acceptable number of averages is between 1 and 255
58	3A	Span weight value, during calibration, must be positive
59	3B	Scale capacity value must be positive
61	3D	Rate-of-Change time units selection must be 0,1 or 2
62	3E	Rate-of-Change time base out of range

### Error Code for Block Write Command #54

97	61	No C2™ load cells found
----	----	-------------------------

### **Block Write in Mapping Compatibility Mode**

You need to map what you want to go into the block registry of the HI 4050 in order to block write commands to that table. If nothing is mapped into the registry the block transfer will write all zeros. There are 63 words maximum in the registry. By using a block write you can write all or some of the words to the registry.

Block write data will be received in the unit's input table, words 0-62.



## Chapter 6 Mapping



**NOTE**

*Mapping is the only option for the HI 4060.*

The HI 4050 RIO Card enables you to configure the instrument in a 1/4, 1/2, 3/4 or FULL rack and map several parameters to the RIO input registry or output registry. Once mapped the user can do Read and Write Block Transfers or Discrete Read and Write commands to the HI 4050 Weight Controller.

### Mapping an Output

- Step 1. If you have not configured the HI 4050 for RIO communication do that now. (See Chapter 3 of this manual for Configuration Instructions)
- Step 2. Connect to the instrument from your PC browser by entering the IP address of the instrument you are using for this application.

**NOTE**

*You cannot map to an Input or Output from the front panel of the instrument.*

**NOTE**

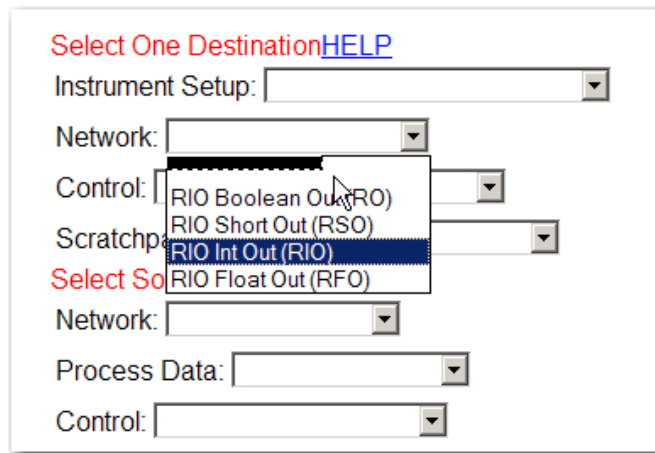
*If you do not know the IP address of the instrument you are mapping, from the front panel go to Configuration, Instrument Setup, IP Address. Enter the IP address listed there in the address field of your browser.*

- Step 3. If you are new to mapping go to Chapter 6 in the HI 4050 Technical.
- Step 4. From the Home Page click on Configuration. The Configuration menu appears. (See Fig. 31)



**FIG. 31 CONFIGURATION MENU/SELECTING MAPPING**

Step 5. Click on Mapping. The Mapping page appears. (See Fig. 32)

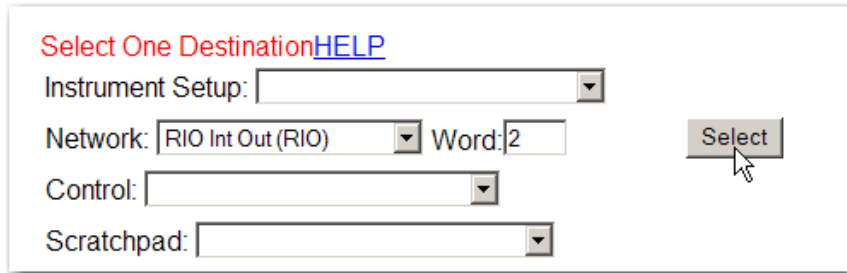


**FIG. 32 MAPPING PAGE/SELECTING DESTINATION**



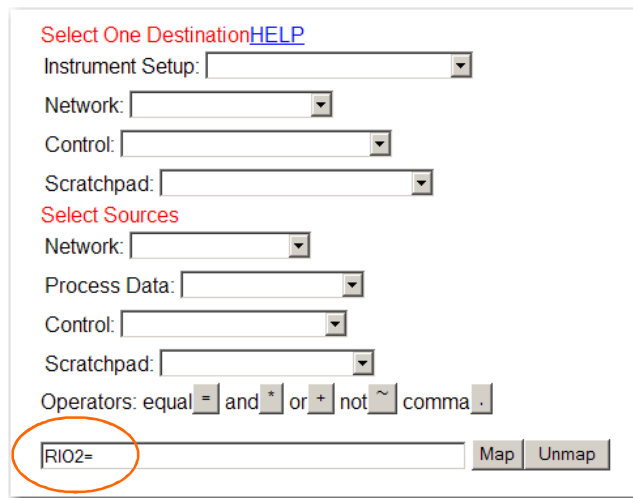
For example: If you want to map Net Weight to the RIO Network Output table to make it available to the network PLC or DCS do the following:

- Step 6. Click on the Network pull down list to select the destination (left side of the equation) for the mapping assignment statement.
- Step 7. Click on the RIO output and data type you want for this application. In our example we selected “RIO Int Out” (RIO) (See Fig. 33)



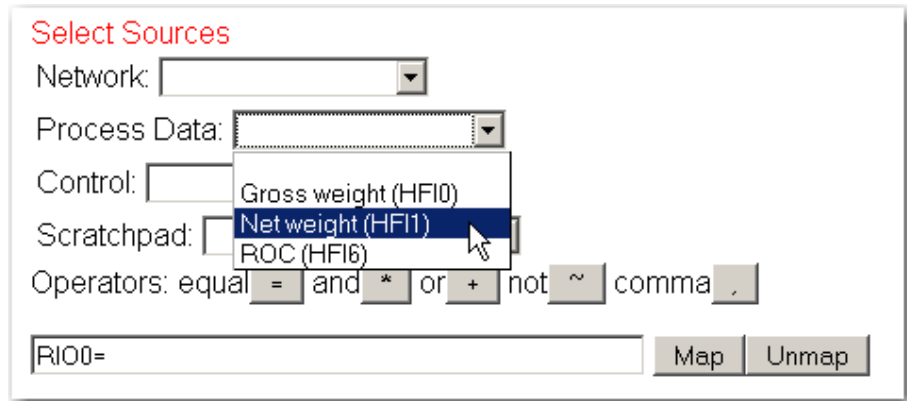
**FIG. 33 MAPPING PAGE/SELECTING DESTINATION**

- Step 8. Click in the Word field and enter the word you want to use for this application.
- Step 9. Click on the Select button. The RIO2 (RIO Int Out word 2) appears in the mapping field with an equals mark. (See Fig. 34)



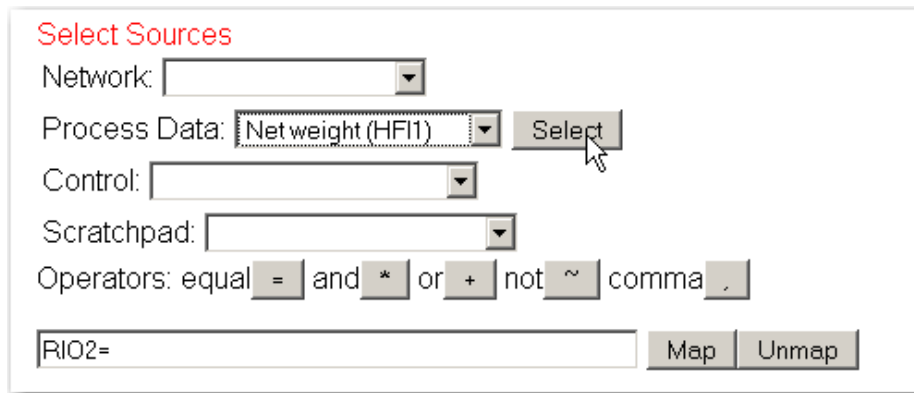
**FIG. 34 RIO2 APPEARS IN THE ASSIGNMENT STATEMENT**

Step 10. To select a source click on the Process Data pull down menu. (See Fig. 35)



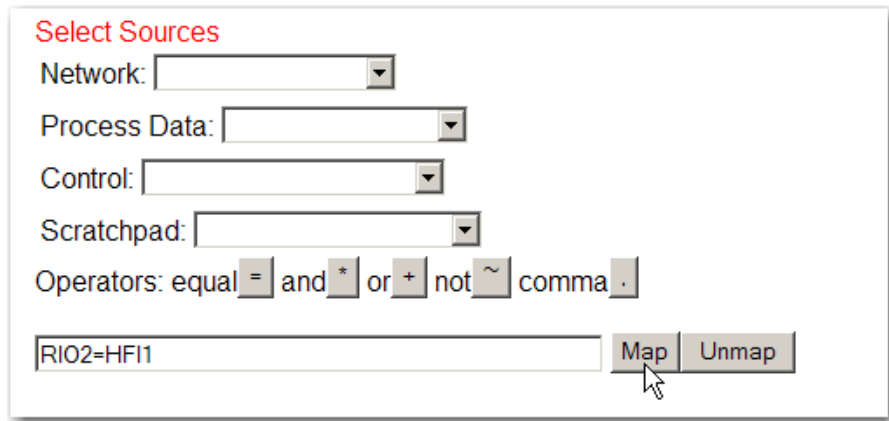
**FIG. 35 SELECTING SOURCE/NET WEIGHT**

Step 11. Click on the Process Data you want to assign to the RIO output table. In our example we selected Net weight (HF11). (See Fig. 36)



**FIG. 36 SELECTING A SOURCE/NET WEIGHT HF11**

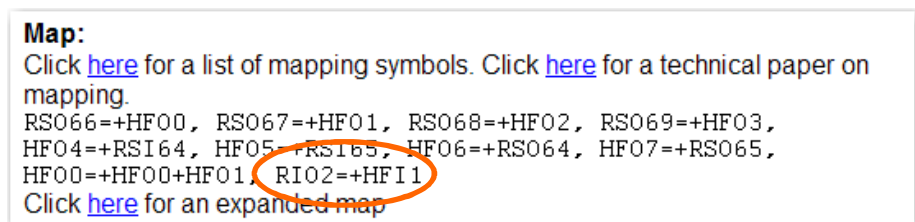
Step 12. Click on the Select button. The source (HF11) appears on the right side of the assignment statement. (See Fig. 37)



**FIG. 37 MAPPING NET WEIGHT TO RIO INT OUTPUT WORD 2**

Step 13. Click on the Map button to complete the mapping process. The complete mapping appears in a list below the map field. (See Fig. 38)

- To Unmap an assignment statement:
  - 1 Highlight and copy the map statement and paste it into the Map field.
  - 2 Click on the Unmap button.



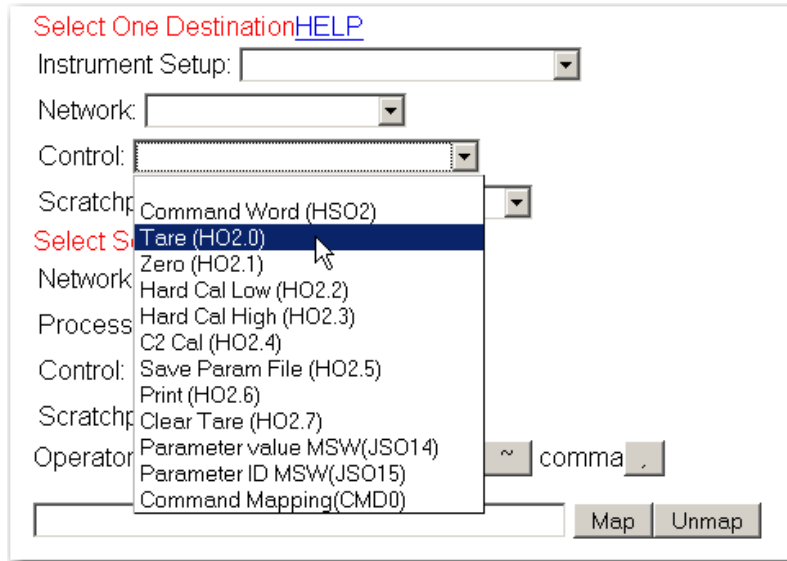
**FIG. 38 NET WEIGHT MAPPED TO THE RIO OUTPUT TABLE**

## Mapping an Input

For example:

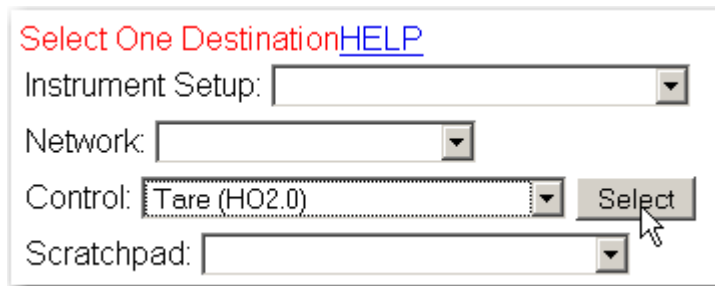
You want to Map the Tare command to the RIO Float Input table. When the PLC sends a command to the tare the instrument it sends it to a location in the Input table.

- Step 1. From the Home page click on Configuration. The Configuration Menu appears.
- Step 2. Click on Mapping. The Mapping page appears.
- Step 3. Click on the destination you want for this applications. In our example we selected a Control, Tare (HO2.0). (See Fig. 39)



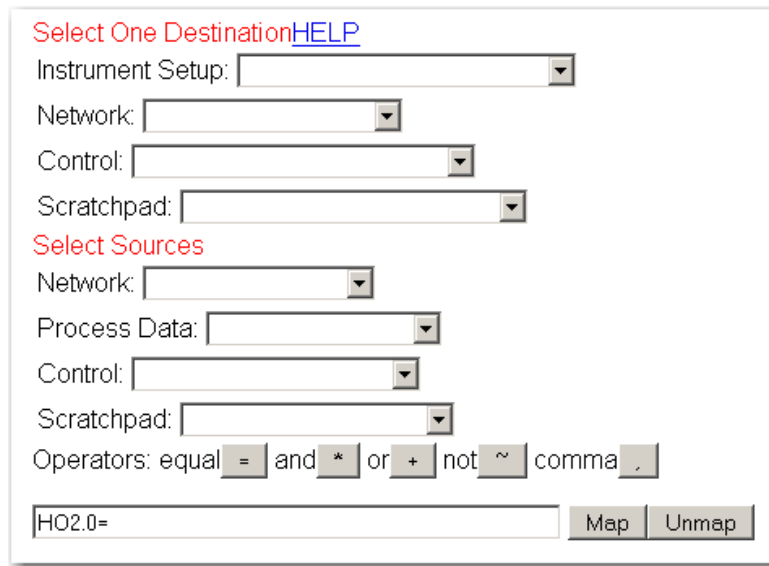
**FIG. 39 DESTINATION/SELECTING TARE COMMAND**

- Step 4. Click on the Select button. (See Fig. 40)



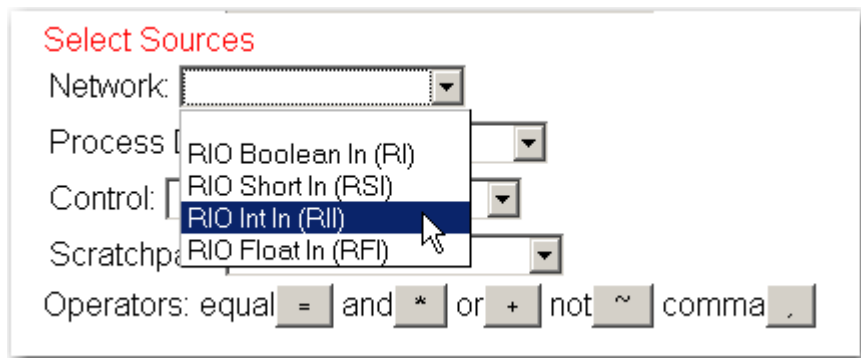
**FIG. 40 SELECTING TARE**

- Step 5. The Tare (HO2.0) appears in the Map field. (See Fig. 41)



**FIG. 41 TARE (HO2.0) SELECTED AS A DESTINATION**

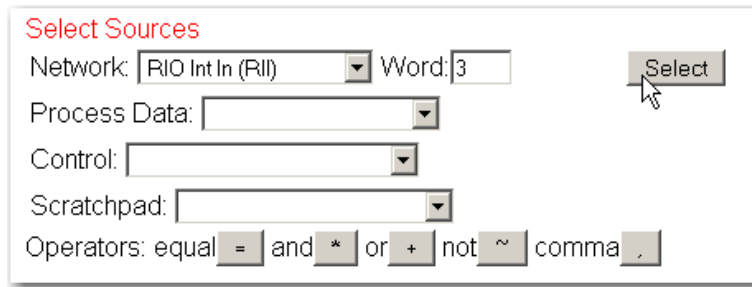
Step 6. To select a source click on the Network pull down list. (See Fig. 42)



**FIG. 42 SELECTING A SOURCE/RIO INT IN**

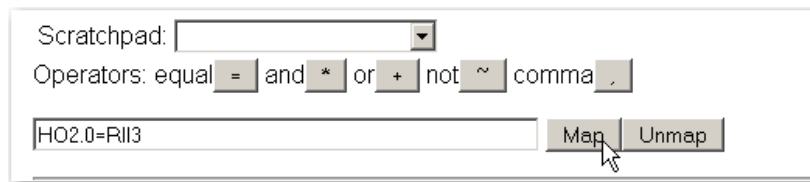
Step 7. Click on the Network datatype you want for this application. In our example we selected RIO Int In (RII).

Step 8. RIO Int In (RII) appears in the Network Field with a word selection text field. (See Fig. 43)



**FIG. 43 SELECTING WORD**

- Step 9. Click in the Word field and type in the word you want to use for this application. In our example we selected word 3.
- Step 10. Click on the Select button. RIO Int In, word 3 (RII3) appears in the Map field. (See Fig. 44)



**FIG. 44 MAPPING RIO INT IN TO TARE**

- Step 11. Click on the Map button to complete the mapping process. The complete mapping appears in a list below the map field. (See Fig. 44)
- To Unmap an assignment statement:
    - 1 Highlight and copy the map statement and paste it into the Map field.
    - 2 Click on the Unmap button.



**FIG. 45 RIO INT IN MAPPED TO TARE**

Step 12. You can now tare the scale by sending a tare command from your PLC to RIO Network In Word 3 Input table, which in turns tares the instrument.





# Chapter 7

## Conversion Charts & Formulas



### Hex Chart

Use the Hex Chart to translate bit values to a hex value.

### Relay Status Example

For example the bit representative of the Relay status byte when setpoints 8,5,3, and 1 are on is (01100000). This eight bit value is represented by two four bit nibbles (0110 and 0000). Looking at the table we see this is equal to a Hex value of 60.

Bit 3	Bit 2	Bit 1	Bit 0	Hex Value
Bit 7	Bit 6	Bit 5	Bit 4	
0	0	0	0	0
0	0	0	1	1
0	0	1	0	2
0	0	1	1	3
0	1	0	0	4
0	1	0	1	5
0	1	1	0	6
0	1	1	1	7
1	0	0	0	8
1	0	0	1	9

**TABLE 6-1: HEX CHART**

Bit 3	Bit 2	Bit 1	Bit 0	Hex Value
Bit 7	Bit 6	Bit 5	Bit 4	
1	0	1	0	A
1	0	1	1	B
1	1	0	0	C
1	1	0	1	D
1	1	1	0	E
1	1	1	1	F

**TABLE 6-1: HEX CHART**

Bit #	15	14	13	12	11	10	9	8	7	6	5	4	3	2	1	0
Decimal Value	32768	16384	8192	4096	2048	1024	512	256	128	64	32	16	8	4	2	1
	ONE WORD															

**TABLE 6-2: BINARY TO DECIMAL CHART**

## Block Write Example /30 Mode

The following is an example using block write #51 to zero the scale. Command #51 is made up of one word. Bits 0-7 represent the address or the command number (00110011 = 51). To activate the scale function, toggle bit #13. This creates a word which has a decimal value of 8,243.

Bit #	0	0	1	0	0	0	0	0	0	0	1	1	0	0	1	1

**TABLE 6-3: BLOCK WRITE EXAMPLE**

## Math Conversion Programs

Math conversion routines, written in ladder logic convert the twenty bit integer data available from the HI 4050WC to a PLC floating point format. Conversely, routines can convert from Floating Point to integer. To convert from integer to floating point, your ladder logic program would follow these steps:

Step 1. Convert the lower sixteen bits into a floating point number.

- Step 2. Test the seventeenth bit (bit 16) and if set, add 65,536 to the floating point number.
- Step 3. Test each subsequent bit and add the appropriate numeric value to the floating point number.



# Index

## Symbols

/30 Compatibility (Default) 2

## Numerics

1/4 Rack Device 31  
20 Bit Resolution 31  
32 Bits 1, 32  
5 Pin Connector 9

## A

About Blind Units 24  
About Block Transfers 31  
About Cable Termination 5  
Address Text Field 20  
Allen-Bradley Company Inc. 2  
Allen-Bradley License 1

## B

Baud Pull Down List 20  
Baud Rate 5  
Bit Shift 25  
Blind Unit Operation Setup 24  
Block Integrity 31  
Block Read Commands 32  
Block Transfer 31  
Block Write Commands 32  
Block Write Example 75  
Board Stacker 6

## C

Cable Termination 5  
CLR Button 14  
Code “99” 32  
Common Applications 3  
Compatibility 17  
Compatibility Pull Down List. 23  
Complete Mapping 67  
Configuration 18  
Configuration from the Front Panel 11  
Configuration from the Web Browser 18  
Configuration Menu 11, 18  
Configuration Modes 2

Configuring RIO Rack Size 15  
Configuring the RIO Address 13  
Configuring the RIO Baud Rate 13  
Confirming RIO Last Quarter 16

## D

Daisy Chain 5  
Data Error 32  
DCS 65  
Dip Switches 6  
Discrete and Block Transfers 1  
Discrete Reads for HI 2151/30  
Compatibility 27  
Discrete Reads in Mapping (HI 4050 WC)  
Compatibility 29  
Discrete Writes for HI 2151/30  
Compatibility 25  
Discrete Writes in Mapping (HI 4050 WC)  
Compatibility 27

## E

Enter Button 11  
Example 27  
Example of Screen Printout 29

## F

Four Byte Numeric Format 31  
Full Status and Weight Data 33

## G

Gross Weight 26

## H

Hex Chart 73  
HI 2151/30 1  
HI 4050-DR Weight Controller 24  
Home Page 68  
Host Programmable Controller 2

## I

Input Image Table 25  
Installing the RIO Option Board 6  
Integrated Technician (IT<sup>®</sup>) 1

## L

lAdder Logic Program 32  
Ladder Logic Programmer 31  
Last Quarter Confirmation Pull Down List  
23

## M

Main Controller Board 7  
Map Button 67  
Map Field 70  
Map Net Weight 65  
Map the Tare Command 67  
Mapped HI 4050 1  
Mapping 2  
Mapping an Input 67  
Mapping an Output 63  
Math Conversion Programs 75  
Monitoring Weighing Parameters 3

## N

Net Weight 26  
Net Weight (HF11) 66  
Network datatype 69  
Network Header 7  
Network Header (J11) 6  
Network In Word 3 Input Table 71  
Network Port 7

## O

Options 11, 19  
Options Menu 11, 19  
Output Image Table 1

## P

Pan Head Screws 8  
PC Browser 63  
Pin Definitions 9  
PLC 1  
PLC Input Image Table 1, 27  
PLC Output Image Table 26  
PLC Output to HI 4050 Input Table 29  
Process Data 66  
Process Data Pull Down Menu 66

## Q

Quarter 16

## R

Rack Size Pull Down List 21  
Rate-of-Change 26  
Relay Status Example 73  
Remote I/O Board Cable Termination Dip  
Switch Configuration 5  
Remote I/O Connections. 9  
Remote I/O Interface 1, 2  
RIO Address 13  
RIO Address Menu 13  
RIO Baud Rate. 12  
RIO Board 6  
RIO Board Options 6  
RIO Int In (RII) 69  
RIO Int In, word 3 (RII3) 70  
RIO Int Out 65  
RIO Int Out Word 2 65  
RIO Label 7  
RIO Last Quarter 17  
RIO Menu 12  
RIO Option Card 8  
RIO Option Card Page 19  
RIO Output Table 66  
RIO Quarter 16  
RIO Rack Size 15

## S

S1 Dip Switches 5  
Save Parameters Button. 24  
Select Button 66  
Selectable Compatibilities 1  
Selecting the Compatibility Mode 17  
Selecting the RIO Starting Quarter 16  
Setpoint Relay Parameter 35  
Setting the Cable Termination Dip  
Switches 6  
Short Glossary of Terms 3  
Source (HF11) 66  
Standoffs 7  
Starting Quarter 22  
Status Byte 26

Status LED 10  
Structure of the Two Words in the PLC  
  Output Image Table 25  
Summary Display 11

## **T**

Tare Value 3  
Totalized Weight 32

## **U**

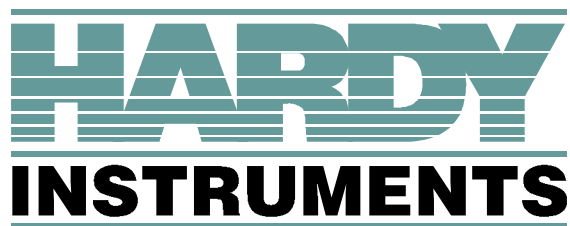
Unmap 70

## **W**

Weight Parameter 26  
Word 64 27  
Word Field 65







**3860 Calle Fortunada, San Diego, CA 92123-1825**  
**Telephone: 1-800-821-5831    FAX: (858) 278-6700**  
**Web Address: <http://www.hardyinstruments.com>**

**Hardy Instruments Document Number: 0596-0306-01 REV E**  
**Copyright October 2007, Dynamic Instruments, All Rights Reserved. Printed in the U.S.A.**